

130

Part no.:	Quantity	
871-9533	1	(part of 0M-820742)
880-5259	1	(part of 0H-0440)
803-0686A	15	(part of 0H-0440)
803-1005	24	(part of 0H-0440)
803-8587	12	(part of 0H-0440)
803-8590A	4	(part of 0H-0440)
872-0030A-001	1	(part of 0H-0440)

Put these parts
in the Zip Bag
872-0030A-001

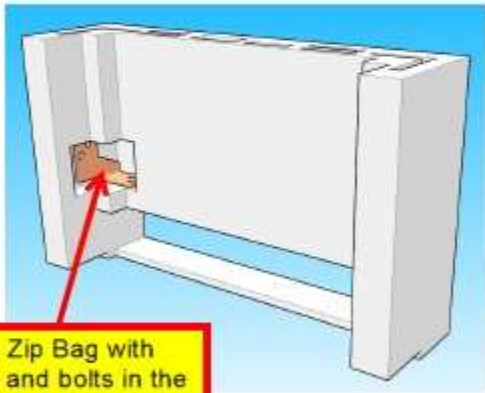

Put the Zip Bag with
screws and bolts in the
"foam" hole together
with busbar 880-5259

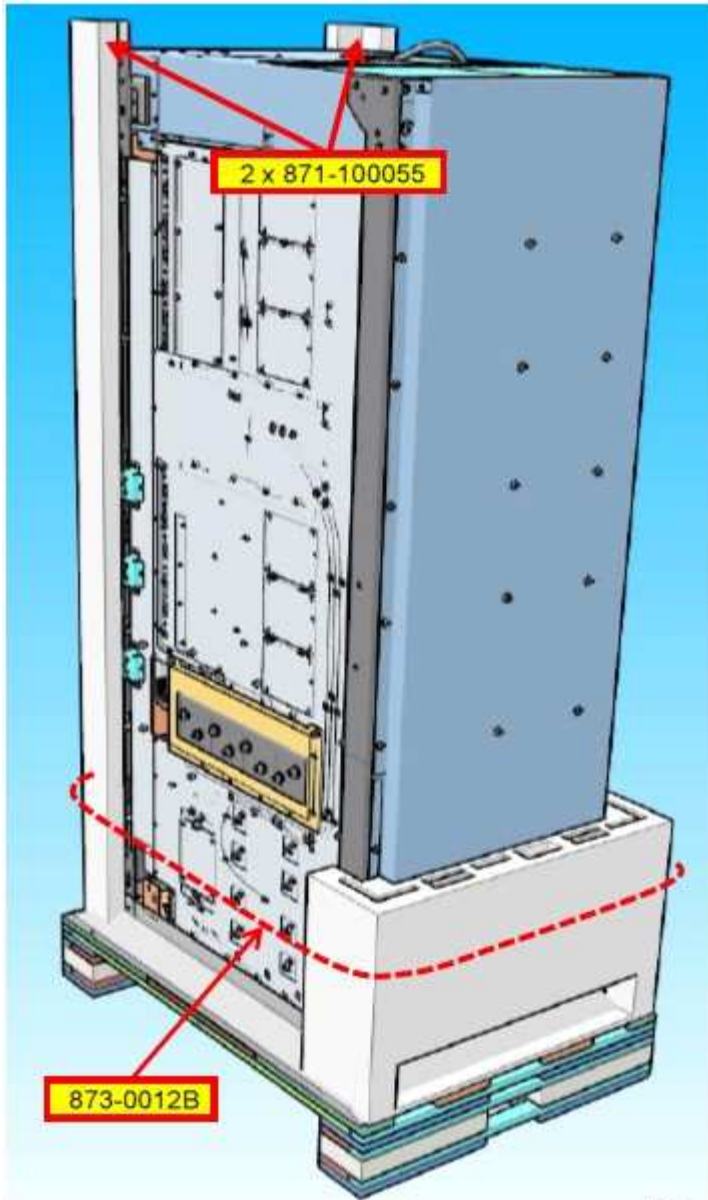

140

Part no.:	Quantity	
871-100055	2	(part of OM-820742)
873-0012B	3mt	(part of OM-820742)

Align 871-9533 with hardware around the rear of 0N-9360 together with the 2 front foam corner profiles 871-100055. Use some tape 873-0012B to hold all the foam pieces together.

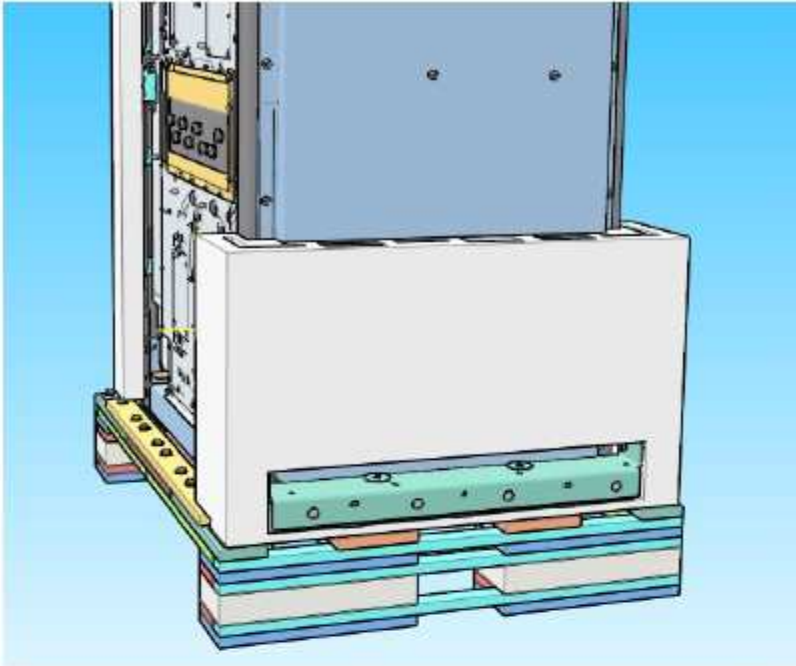

150

Part no.:	Quantity	
0M-816684A	1	(part of 0H-0440)
0M-818242B	1	(part of 0H-0440)
872-0214A	1	(part of 0H-0440)
873-0012B	1mt	(part of 0H-0440)

Before inserting start by putting 0M-816684A onto the piece of wrap. Wrap this with 1 "turn" before adding 0M-818242A and finishing the wrapping. By doing this we will avoid the two 0M# damaging each other. Finally use tape 873-0012B to secure the wrap.

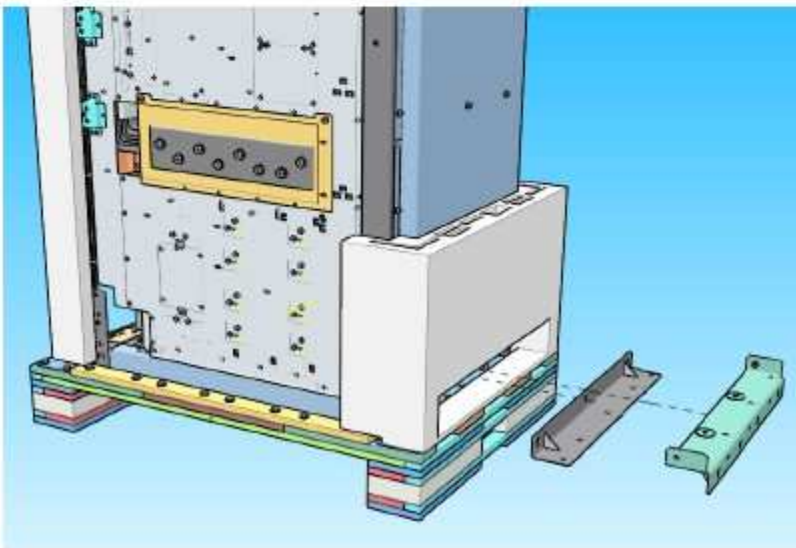

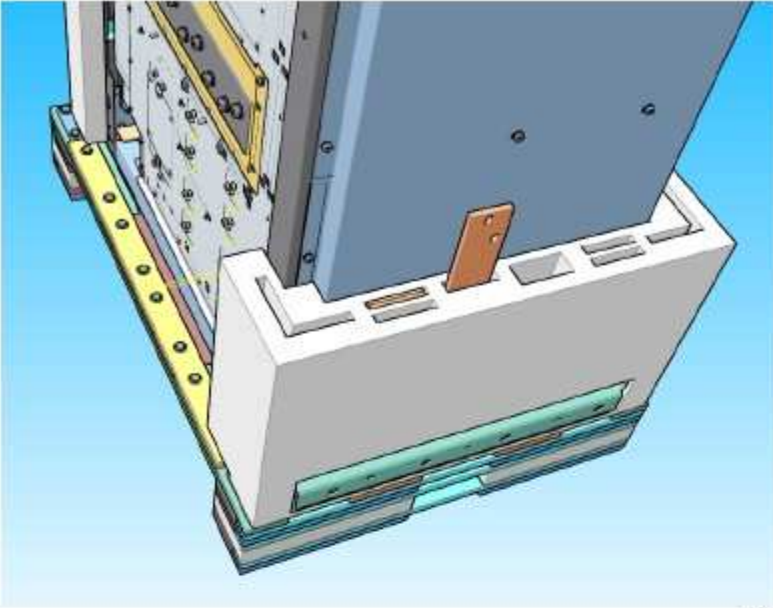

160

Part no.:	Quantity	
880-10146A	1	(part of 0H-0440)
0M-140035A	1	(part of 0H-0440)

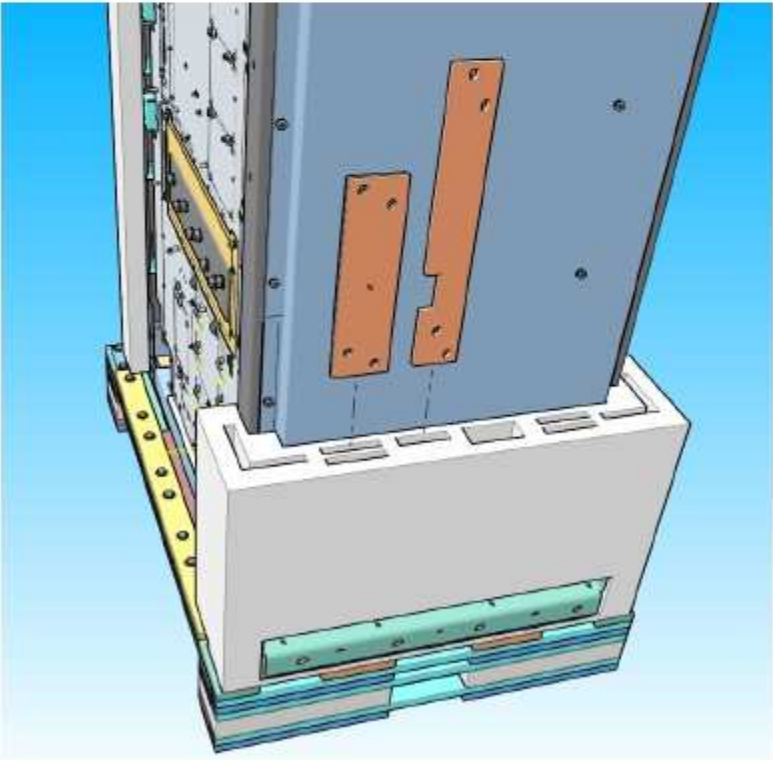

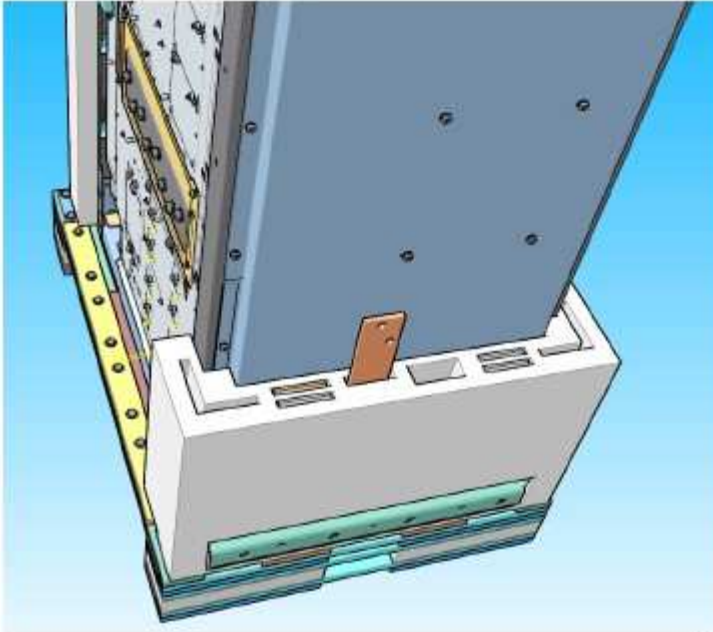

170

Part no.:	Quantity
0M-97886A	3

(part of 0H-0440)

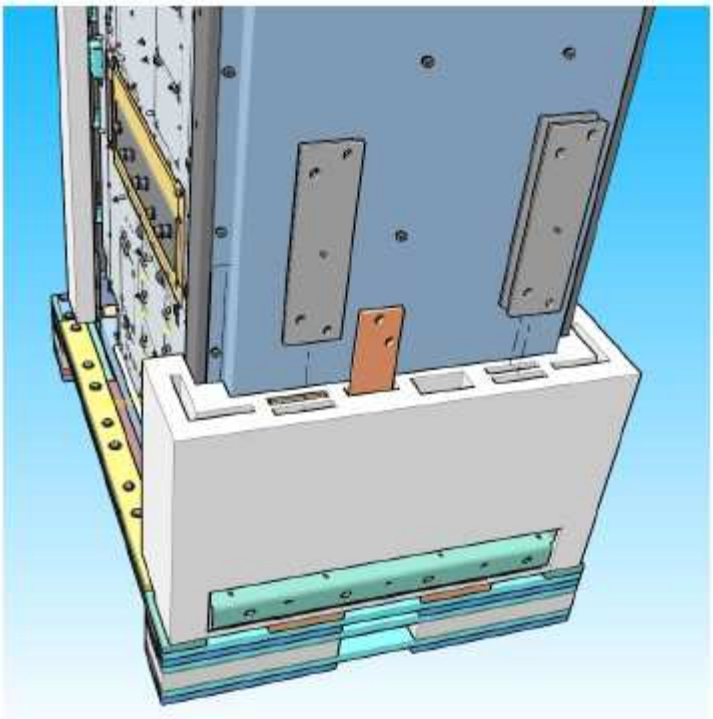

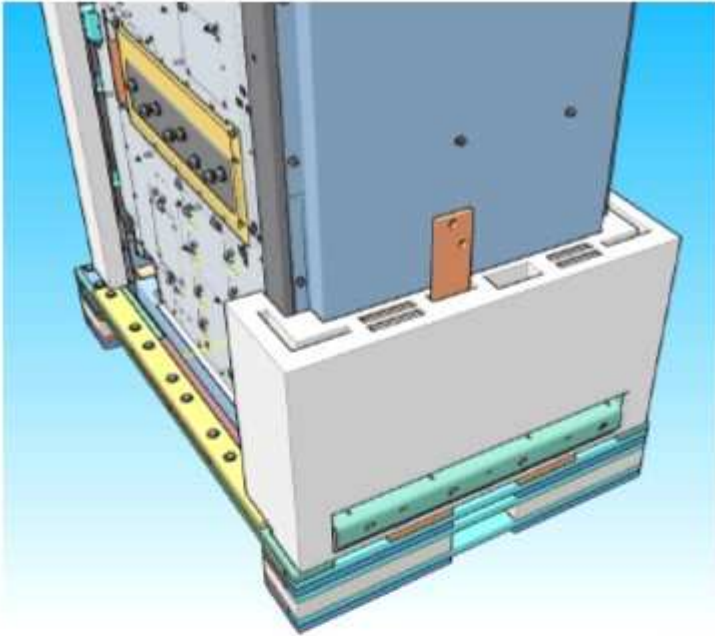

180

Part no.:	Quantity
0M-819336B	1

(part of 0H-0440)

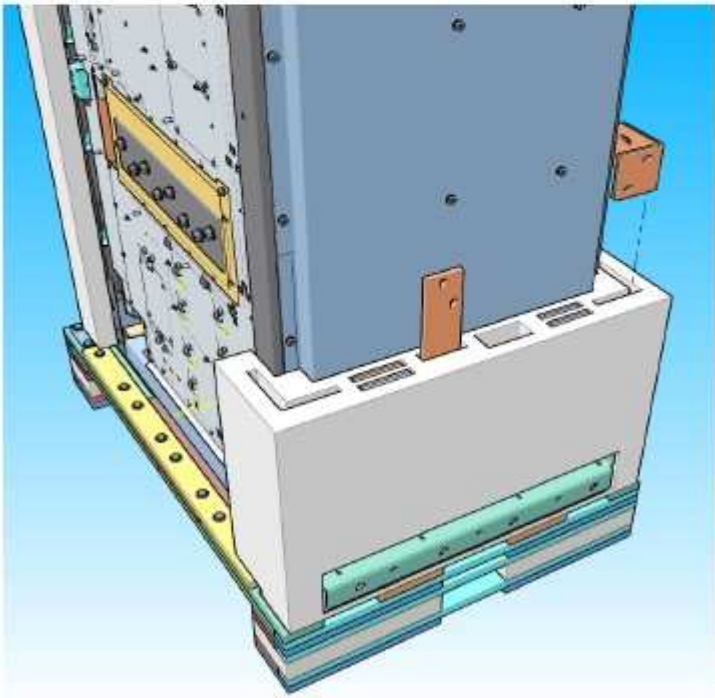

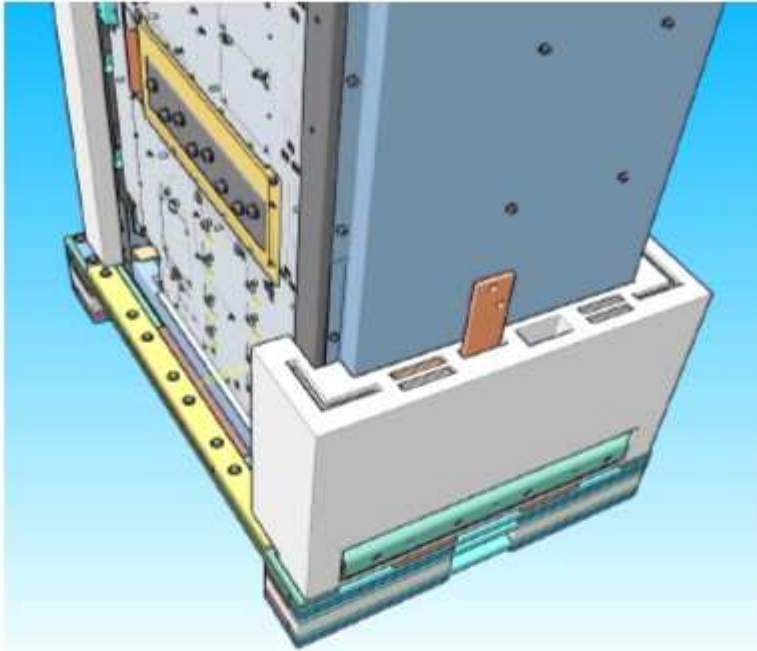

190

Part no.:	Quantity	
0M-97885B	3	(part of 0H-0440)
872-5000A	2	(part of 0H-0440)
885-3326	2	(part of 0H-0440)

Wrap these 2 0M-97885A in 1 piece of wrap 872-5000A each before inserting into the foam to avoid them from scratching the busbars below.
Paste 1 label 885-3326 to each 872-5000A.

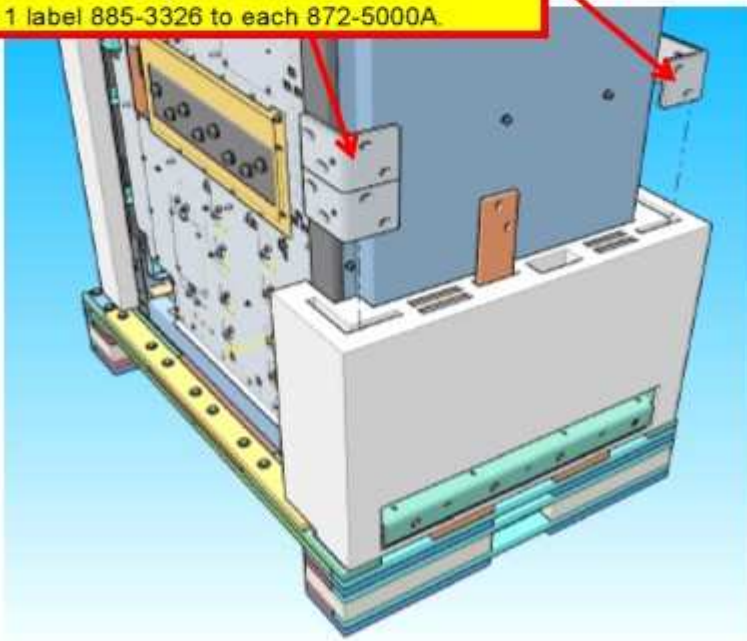

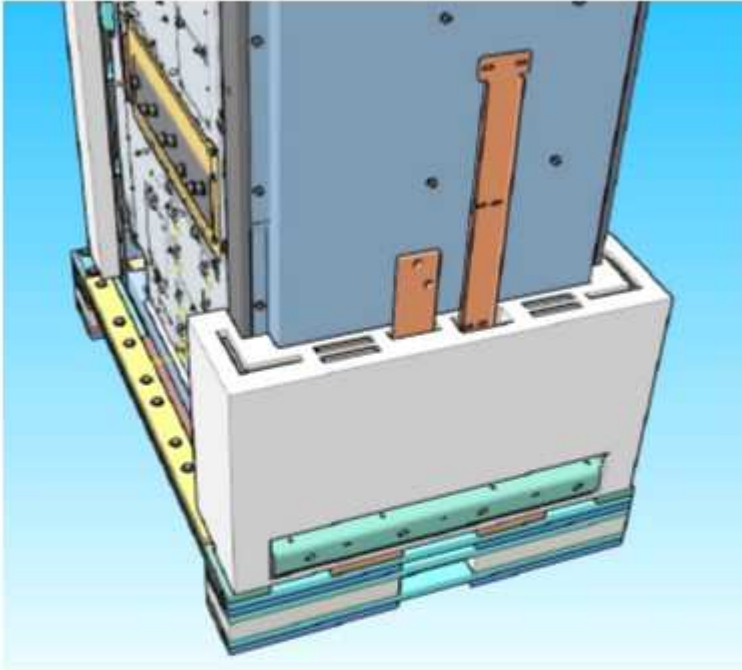

200

Part no.:	Quantity	
0M-821220	1	(part of 0H-0440)
872-0214A	1	(part of 0H-0440)
873-0012B	1mt	(part of 0H-0440)

Wrap 0M-821220 in wrap 872-0214A before inserting.
Secure the wrap with tape 873-0012B

