

Operation and Maintenance Manual

InRow[®] Air-Cooled, Direct Expansion

InRow[®] RD 10kW

ACRD100, ACRD101

990-3212C-001

Publication Date: November 2014

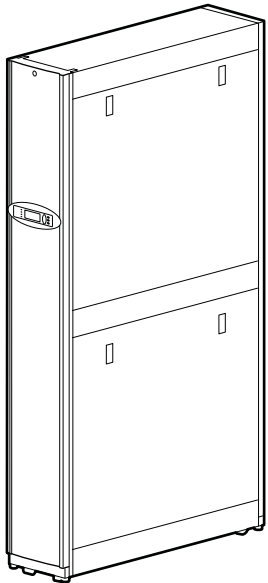

Schneider Electric IT Corporation Legal Disclaimer

The information presented in this manual is not warranted by the Schneider Electric IT Corporation to be authoritative, error free, or complete. This publication is not meant to be a substitute for a detailed operational and site specific development plan. Therefore, Schneider Electric IT Corporation assumes no liability for damages, violations of codes, improper installation, system failures, or any other problems that could arise based on the use of this Publication.

The information contained in this Publication is provided as is and has been prepared solely for the purpose of evaluating data center design and construction. This Publication has been compiled in good faith by Schneider Electric IT Corporation. However, no representation is made or warranty given, either express or implied, as to the completeness or accuracy of the information this Publication contains.

IN NO EVENT SHALL SCHNEIDER ELECTRIC IT CORPORATION, OR ANY PARENT, AFFILIATE OR SUBSIDIARY COMPANY OF SCHNEIDER ELECTRIC IT CORPORATION OR THEIR RESPECTIVE OFFICERS, DIRECTORS, OR EMPLOYEES BE LIABLE FOR ANY DIRECT, INDIRECT, CONSEQUENTIAL, PUNITIVE, SPECIAL, OR INCIDENTAL DAMAGES (INCLUDING, WITHOUT LIMITATION, DAMAGES FOR LOSS OF BUSINESS, CONTRACT, REVENUE, DATA, INFORMATION, OR BUSINESS INTERRUPTION) RESULTING FROM, ARISING OUT, OR IN CONNECTION WITH THE USE OF, OR INABILITY TO USE THIS PUBLICATION OR THE CONTENT, EVEN IF SCHNEIDER ELECTRIC IT CORPORATION HAS BEEN EXPRESSLY ADVISED OF THE POSSIBILITY OF SUCH DAMAGES. SCHNEIDER ELECTRIC IT CORPORATION RESERVES THE RIGHT TO MAKE CHANGES OR UPDATES WITH RESPECT TO OR IN THE CONTENT OF THE PUBLICATION OR THE FORMAT THEREOF AT ANY TIME WITHOUT NOTICE.

Copyright, intellectual, and all other proprietary rights in the content (including but not limited to software, audio, video, text, and photographs) rests with Schneider Electric It Corporation or its licensors. All rights in the content not expressly granted herein are reserved. No rights of any kind are licensed or assigned or shall otherwise pass to persons accessing this information.

This Publication shall not be for resale in whole or in part.

Table of Contents

Safety.....	1
Important Safety Information	1
Safety Notices During Operation	2
General Information.....	4
Overview.....	4
Save these instructions	4
Cross-reference symbol used in this manual	4
Manual updates	4
Commissioning.....	5
Inspection Checklists	5
Initial inspection checklist	5
Electrical inspection checklist	6
Mechanical inspection checklist	7
User interface inspection checklist	8
Start-up inspection checklist	8
Final inspection checklist	8
Charging With Refrigerant	9
Calculating R410A charge	9
Charging the equipment	11
Compressor Oil Charge	13
Oil charging procedure	13
Operation.....	15
Display Interface.....	15
Using the Display Interface.....	16
Scrolling status screens	16
Main menu screens	16
Navigating the main menu	17
Navigating the sub-menus	17
Using the Path statement	18
Password entry	18
Start the cooling unit	19
Stop the cooling unit	19

General Configuration	20
Cooling unit configuration	20
Contacts	21
View the state of input and output contacts	21
Edit the normal state of input and output contacts	21
Cooling Group Configuration	22
Configure the cooling group	22
Identify the cooling unit	23
Configure Modbus	23
Control the Environment	24
Setpoints	24
PID settings	25
Tune the PID loop	25
Run hours	26
Thresholds	26
Service intervals	26
Display Settings	27
Password and time-out	27
Date and time	27
Adjust display settings	28
Display units	28
Network Configuration	28
Configure network	28
View Status Readings	29
Scrolling status screens	29
Cooling unit status	29
Cooling group status	30
About the cooling unit	30
Event Log	30
View the event log	30
Clear the event log	30
Respond to Alarms	31
View active alarms	31
Clear active alarms	31
Alarm messages and suggested actions	31

Network Management Card..... 34

- Quick Configuration 34
 - Overview 34
 - TCP/IP configuration methods 34
 - Device IP Configuration Wizard 35
 - .ini file utility 35
 - BOOTP & DHCP configuration 35
 - Local access to the control console 36
 - Remote access to the control console 36
 - Control console 37
- Access a Configured Network Management Card 38
 - Overview 38
 - Web interface 38
 - Telnet and SSH 38
 - Simple Network Management Protocol (SNMP) 39
 - FTP/SCP 39
 - Modbus 39
- Recover From a Lost Password 40

Maintenance 41

- Monthly Preventive Maintenance 41
 - Environment 41
 - Cleanliness 41
 - Mechanical 42
 - Electrical 42
- Quarterly Preventive Maintenance 43
 - Mechanical 43
 - Functional tests 43
- Semi-Annual Preventive Maintenance 44
 - Cleanliness 44

Troubleshooting..... 45

Safety

Important Safety Information

Read the instructions carefully to become familiar with the equipment before trying to install, operate, service, or maintain it. The following special messages may appear throughout this manual or on the equipment to warn of potential hazards or to call attention to information that clarifies or simplifies a procedure.



The addition of this symbol to a Danger or Warning safety label indicates that an electrical hazard exists which will result in personal injury if the instructions are not followed.



This is the safety alert symbol. It is used to alert you to potential personal injury hazards. Obey all safety messages that follow this symbol to avoid possible injury or death.

⚠ DANGER

DANGER indicates an imminently hazardous situation which, if not avoided, **will result in** death or serious injury.

⚠ WARNING

WARNING indicates a potentially hazardous situation which, if not avoided, **can result in** death or serious injury.

⚠ CAUTION

CAUTION indicates a potentially hazardous situation which, if not avoided, **can result in** minor or moderate injury.

NOTICE

NOTICE addresses practices not related to physical injury including certain environmental hazards, potential damage or loss of data.

Safety Notices During Operation

Read and adhere to the following important safety considerations when working with this equipment. Follow all local and national regulations when handling refrigerants.

⚠ ⚠ DANGER
HAZARD OF ELECTRIC SHOCK, EXPLOSION, OR ARC FLASH
<ul style="list-style-type: none">• Apply appropriate personal protective equipment (PPE) and follow safe electrical work practices. See NFPA 70E or CSA Z462.• This equipment must be installed and serviced by qualified personnel only.• Turn off all power supplying this equipment before working on or inside the equipment.• Always use a properly rated voltage sensing device to confirm power is off.• Replace all devices, doors, and covers before turning on power to this equipment.
Failure to follow these instructions will result in death or serious injury.

⚠ WARNING
HAZARD TO EQUIPMENT OR PERSONNEL
All work must be performed by Schneider Electric qualified personnel.
Failure to follow these instructions can result in death, serious injury, or equipment damage.

⚠ WARNING
HAZARD FROM MOVING PARTS
Keep hands, clothing, and jewelry away from moving parts. Check the equipment for foreign objects before closing the doors and starting the equipment.
Failure to follow these instructions can result in death, serious injury, or equipment damage.

⚠ WARNING
HAZARD OF EQUIPMENT FALLING OVER
<ul style="list-style-type: none">• Use two or more persons at all times to move or turn this equipment.• Always push, pull, or turn while facing the front and rear of this equipment. Never push pull, or turn while facing the sides of this equipment.• Slowly move this equipment across uneven surfaces or door thresholds.• Lower leveling feet to floor when this equipment is at rest.• Lower leveling feet and attach joining brackets to adjacent racks when this equipment is in final position.
Failure to follow these instructions can result in death, serious injury, or equipment damage.

⚠ CAUTION

HAZARD TO EQUIPMENT OR PERSONNEL

Ensure that all spare parts and tools are removed from the equipment before operating it

Failure to follow these instructions can result in injury or equipment damage.

NOTICE

STATIC ELECTRICITY HAZARD

Circuit boards contained within this unit are sensitive to static electricity. Use one or more electrostatic-discharge device while handling the boards.

Failure to follow these instructions can result in equipment damage.

General Information

Overview

Save these instructions

This manual contains important instructions that must be followed during installation, operation, and maintenance of the cooling unit.

Cross-reference symbol used in this manual



See another section of this document or another document for more information on this subject.

Manual updates

Check for updates to this manual on the Schneider Electric Web site, www.schneider-electric.com/support. Select the **Download Documents and Software** link under the **Support** tab and enter the manual part number or SKU for your equipment in the search field. See the back cover of this manual for the part number.

Commissioning

After installation is complete, verify that all components are working properly and that the cooling unit is ready to begin operation.

Inspection Checklists

Initial inspection checklist

⚠ ⚠ WARNING
OPERATIONAL HAZARDS
<ul style="list-style-type: none">• The cooling unit operates under pressure. Take proper safety precautions when connecting gauges or servicing piping.• Do not operate the cooling unit with any cover, guard, door, or panel removed unless the instructions indicate otherwise. Then, proceed with extreme caution.• Do not run service utilities in front of the fan outlets.
Failure to follow these instructions can result in death, serious injury, or equipment damage.

NOTE: The vapor barrier minimizes moisture infiltration. Without a vapor barrier, it will be difficult to maintain the humidity in the room. Do not introduce unconditioned outside air into the space.

The initial inspection ensures that the cooling unit has been properly installed, the location of the cooling unit has been properly prepared, and the cooling unit is free of damage.

NOTE: A minimum of 900 mm (36 in.) of clear floor space in front of and behind the cooling unit is required for service access. To roll the cooling unit out of the row, there must be a minimum of 1200 mm (48 in.) of clear floor space in front of or behind the cooling unit. Out-of-row service requires 760 mm (30 in.) of side clearance in addition to the front and rear clearance.

Ensure that:

-
- The installation procedure is complete according to the installation manual.

 - The walls, floor, and ceiling of the room where the cooling unit is located are sealed with a vapor barrier.

 - There is no evidence of damage to the cooling unit.

 - The cooling unit is level and joined to the adjacent racks.

 - The cooling unit is not installed at the open end of a row.

 - The clearance around the cooling unit is in accordance with local and national codes and regulations as well as the installation manual.

Electrical inspection checklist

⚠ ⚠ WARNING

ELECTRICAL HAZARD

- Electrical service must conform to local and national electrical codes and regulations.
- The equipment must be grounded.

Failure to follow these instructions can result in death, serious injury, or equipment damage.

The electrical inspection verifies that all electrical connections are secure and correct and that the cooling unit is properly grounded.

Ensure that the:

-
- Incoming voltages match the phase and voltage listed on the nameplate.
-
- Electrical wiring complies with local and national codes and regulations.
-
- The cooling unit is properly grounded.
-
- Electrical connections are tight, including contactors, terminal blocks, controllers, switches, relays, auxiliary devices, and field connections.
-

Mechanical inspection checklist

<i>NOTICE</i>
HAZARD TO EQUIPMENT <ul style="list-style-type: none">• The equipment is shipped from the factory with a nitrogen holding charge. Remove the nitrogen holding charge using the service valves located on the internal refrigerant piping.• Improperly installed piping may result in improper operation and possible damage to the cooling unit or surrounding equipment. <p>Failure to follow these instructions can result in equipment damage.</p>

The mechanical inspection verifies that all mechanical components and connections are secure and tight and ready for start-up and system charging. The inspection ensures that field piping is properly installed to promote oil return to the compressor.

Ensure that the:

-
- Fans are turning freely and that the blades are not distorted or bent.

 - Condensate drain line is at least the size of the drain connection.

 - Piping joints are tight.

 - Mechanical connections are tight, including compressor and receiver rotolock connections.

 - Refrigerant piping size is correct according to the line size table in the installation manual.

 - Vertical, horizontal, and total run lengths of the liquid, discharge, and suction lines are recorded.

 - Number of 45- and 90-degree bends in the refrigerant piping are recorded.

 - Field-installed traps and piping are in accordance with the installation manual and follow proper piping practices.

 - Refrigerant piping is adequately supported and isolated when necessary.

 - Field-installed service valves are open.

 - Pressure relief valve is installed in accordance with the installation manual as well as local and national codes and regulations.

 - Piping in the building and on the roof is properly insulated.

 - Covers and guards are in place.

User interface inspection checklist

The user interface inspection verifies that the sensors and internal communications links of the cooling unit are installed properly.

Ensure that:

-
- An A-Link bus is connected to each cooling unit in the group and a terminator is plugged into all unused A-Link connectors.

 - The input contacts and output relays are connected correctly.

 - The building management system is connected correctly and a terminator is wired into the final unit between Modbus D0 and Modbus D1.

 - The rack temperature sensors are installed correctly.

 - The network port is connected correctly and an IP address has been assigned to the equipment.
-

Start-up inspection checklist

The start-up inspection ensures that the cooling unit is operating properly after the initial start-up. This inspection verifies that all modes of operation are working correctly and that the cooling unit is ready for normal operation.

While the cooling unit is operating, ensure that the:

-
- Cooling unit is free from malfunctions, unusual vibrations, or other irregularities in each mode of operation.

 - Cool cycles engage.

 - Air filters are clean and free of debris. Replace air filters with Schneider Electric part number 875-2013.

 - Clogged filter alarm is operating properly:
Cover 1/3 of the filter area and monitor alarm performance.

 - Compressor suction and discharge pressures are recorded.

 - Sight glass moisture sensor is green.
-

Final inspection checklist

The final inspection verifies that the system is clean and the start-up form has been sent to Schneider Electric.

Ensure that:

-
- System is clean and free from debris.

 - Packaging materials are disposed of properly.

 - Start-up form was completed and sent to Schneider Electric.
-

Charging With Refrigerant

Calculating R410A charge

Use the following table and formula when calculating the total R410A charge.

Condenser Model	Selected Ambient Temp. °C (°F)	Condenser Summer Charge kg (lb)	Condenser Flooded Charge in kg (lb) for Different Minimum Outdoor Ambient Temperatures				
			4°C (40°F)	-7°C (20°F)	-18°C (0°F)	-29°C (-20°F)	-40°C (-40°F)
ACCD75214	35 (95)	2.2 (4.9)	5.48 (12.1)	5.85 (12.9)	6.03 (13.3)	6.17 (13.6)	6.30 (13.9)
ACCD75214	40 (105)	2.2 (4.9)	5.48 (12.1)	5.85 (12.9)	6.03 (13.3)	6.17 (13.6)	6.30 (13.9)
ACCD75215	46 (115)	3.85 (8.5)	9.57 (21.1)	10.16 (22.4)	10.48 (23.1)	10.70 (23.6)	10.93 (24.1)
ACCD75216	35 (95)	1.36 (3)	3.08 (6.8)	3.26 (7.2)	3.36 (7.4)	3.45 (7.6)	3.49 (7.7)
ACCD75218, ACCD75220*	40 (105)	1.36 (3)	3.08 (6.8)	3.26 (7.2)	3.36 (7.4)	3.45 (7.6)	3.49 (7.7)
ACCD75217, ACCD75219	46 (115)	2.27(5)	6.12 (13.5)	6.53 (14.4)	6.71 (14.8)	6.89 (15.2)	7.03 (15.5)

* ACCD75220 is CCC certified for use in China.

ACR Pipe Size (OD)	Type of Fitting or Valve - Equivalent Length of Pipe in m (ft)				
	Gate Valve	Standard Elbow 90 °	Reduced Coupling	Side Outlet T	Angle Valve
1/2 in.	0.18 (0.6)	0.43 (1.4)	0.43 (1.4)	0.82 (2.7)	1.83 (6.0)
5/8 in.	0.21 (0.7)	0.49 (1.6)	0.49 (1.6)	0.91 (3.0)	2.13 (7.0)

Recommended Line Sizes

Equivalent length m (ft)	Line Type	Air-cooled ACRD Units
15 (50)	Discharge line (horizontal)	5/8 in. OD ACR
	Discharge line (vertical)	1/2 in. OD ACR
	Liquid line	1/2 in. OD ACR
30 (100)	Discharge line (horizontal)	5/8 in. OD ACR
	Discharge line (vertical)	1/2 in. OD ACR
	Liquid line	1/2 in. OD ACR
16 (150)	Discharge line (horizontal)	5/8 in. OD ACR
	Discharge line (vertical)	1/2 in. OD ACR
	Liquid line	1/2 in. OD ACR

NOTE: All refrigerant pipes must be straight ACR to have 39 bar (565 psig) or above MWP. Equivalent length of 1/2 in. OD discharge line pipe should be kept less than 18 m (60 ft). Total equivalent length of the discharge line should be less than 46 m (150 ft) to prevent excessive hot gas pressure drop which can increase the discharge pressure during hot summer days. To have 61 m (200 ft) total equivalent discharge pipe length the load must be reduced by 5%.

Total charge = Equipment charge + condenser summer charge + condenser flooded charge (for minimum possible ambient temperature) + liquid R410A in liquid pipe

Equipment charge: 1.6 kg (3.5 lb)

Quantity of R410A in 1/2 in. OD liquid line: (area) x (length in ft) x (density): $0.0010554 \text{ (ft}^2\text{)} \times L \text{ (ft)} \times 61.0 \text{ (lbm/ft}^3\text{)}$

Density of liquid R410A at 40.6°C (105°F) and 260 psig: 0.98 g/cm^3 (61.0 lbm/ft³)

Cross sectional area for 1/2 in. OD pipe is 0.0010554 ft².

Liquid line charge for 1/2 in. OD ACR copper tube: 0.095 kg/m (0.0644 lb/ft).

Cross sectional area for 5/8 in. OD pipe is 0.001619 ft².

Quantity of R410A in 5/8 in. OD liquid line: (area) x (length in ft) x (density): $0.001619 \text{ (ft}^2\text{)} \times L \text{ (ft)} \times 61.0 \text{ (lbm/ft}^3\text{)}$.

Liquid line charge for 5/8 in. OD ACR copper tube: 0.146 kg/m (0.099 lb/ft).

Example:

Calculate the total R410A charge for an FCB5 condenser with 25 ft of 1/2 in. OD liquid piping. Minimum outdoor design temperature is -28.9°C (-20°F).

NOTE: Imperial units are used in this example.

Total R410A charge: $3.5 + 4.9 + 13.6 + (25 \times 0.0644) = 23.6 \text{ lb}$.

Charging the equipment

⚠ WARNING
HAZARD TO EQUIPMENT OR PERSONNEL
All work must be performed by Schneider Electric qualified personnel.
Failure to follow these instructions can result in death, serious injury, or equipment damage.

⚠ CAUTION
HAZARD OF HIGH PRESSURE REFRIGERANT OR EQUIPMENT DAMAGE
<ul style="list-style-type: none">• Use R410a refrigerant only.• Use hose and manifold set suitable for R410a with a minimum pressure rating of 50 bar (725 PSIG).• The unit display should be used to obtain pressure readings.
Failure to follow these instructions can result in injury or equipment damage.

NOTICE
HAZARD TO EQUIPMENT
Introducing a fast charge of liquid refrigerant through the suction port may damage the compressor.
Failure to follow these instructions can result in equipment damage.

R410A is a blend refrigerant. When charging equipment with blend refrigerants, only liquid refrigerant must be charged.

1. Ensure the ball valves are open.
2. Confirm the calculated system charge.
3. Connect the refrigerant cylinder to the charging or gauge port on the receiver outlet valve. Open the receiver valve approximately half way.
4. Charge liquid refrigerant into the high side of the system until the system pressures equalize. While the unit is NOT operational, charge liquid to the suction (low side) line to simply equalize pressures throughout the system DO NOT start the system until the pressure equalizes. Please note charging liquid to the suction port during operation may damage or reduce the life of the compressor.
5. Prior to starting the system, make sure all system valves are open and the system high side pressure remains above 24.8 bar (360 psi). This may require blocking the condenser inlet slightly. Remove any blocking panels after charging is complete.
6. Start the cooling unit. See “Start the cooling unit” on page 19 for more information.
7. Once the system is operational, front seat the receiver service valve and continue charging liquid at the service port down stream of the receiver shutoff valve, until the calculated charge is complete. When this procedure is complete, fully back seat the receiver shutoff valve. Leave charging hoses in place in the event additional charging is required.
8. Charge the rest of the calculated liquid refrigerant very slowly through the suction port.

9. Verify that the sightglass is clear. If there is excessive bubbling in the sightglass, make sure the system high side pressure is above 23.4 bar (340 psi) and Superheat and Subcooling are within parameters (10-12 for Superheat and 8-10 for Subcooling). If additional charging is required, front seat the receiver shutoff valve and weigh in the additional charge at the service port.

NOTE: Since good performance during low ambient temperatures depends on proper refrigerant charge, it is very important that this phase of the installation procedure be done carefully. Poor system performance can be due to too little or too much charge.

Compressor Oil Charge

NOTICE

HAZARD TO EQUIPMENT

- This procedure is to be done by qualified personnel only.
- Do not charge the compressor with too much oil, or compressor damage could result. The only way to drain oil from the compressor is to remove the compressor from the equipment, which cannot be done when the equipment is in the row.

Failure to follow these instructions can result in equipment damage.

You may need to add oil to air-cooled equipment, depending on the condenser size and the lengths of tube running between the equipment and the condenser.

Oil charging procedure

1. Calculate the approximate amount of additional oil needed using the following formula:

$$0.7 \times \{(R \times 0.022 \times 16) - (C \times 0.10)\} = A$$

- **R** — Refrigerant in the system (this amount should have been recorded during installation)
- **C** — Compressor oil charge (in fluid ounces)
- **A** — Amount of additional oil (in fluid ounces).

NOTE: The compressor used in this equipment comes with an internal oil charge of 1064 ml (36 fl oz).

In the following example, there are 20 pounds of refrigerant in the system.

$$(20 \times 0.022 \times 16) - (36 \times 0.10)$$

$$0.7\{(20 \times 0.022 \times 16) - (36 \times 0.1)\} = 2.3 \text{ fluid ounces of additional oil.}$$

2. Prepare to add oil:
 - a. Use a new, sealed oil can and a manual oil pump. The pump hose must be sized for 1/4 in. flare fittings and must include a valve depressor at its end, which will open the valve on the Schrader service port of the compressor.
 - b. At a minimum, use a quality POE oil with a viscosity of 32 cst, 160 sus at 40°C (104°F). Suggested oils: Danfoss Maneurop 160 PZ Polyolesteroil, the approved type of oil for this equipment. Approved alternative oil types:
 - CPI (Lubrizol) reference: CP-2931AH or CP-2931A or equivalent
 - ICI_UNIQUEMA reference: Emkarate RL32H or equivalent
3. Purge the pump and hose:
 - a. Ensure that the oil pump is clean. Insert the pump in the oil container and make sure that the container is open to the atmosphere for as short a period of time as possible. When available, use a plug adapter kit to further reduce the exposure of the oil to the atmosphere.
 - b. Bleed all air from the pump and hose with a few strokes of the pump. Purging the pump removes the moisture-saturated oil left inside the hose from previous usage.
 - c. Connect the hose to the service port of the compressor immediately after purging to avoid moisture contamination.
4. While the equipment is running, charge the oil through the suction service port. Pump the oil very slowly.

NOTICE

HAZARD TO EQUIPMENT

Be careful not to charge more oil than is necessary. Excessive oil in the system may cause system damage, including the following:

- Failure of compressor due to oil slugging.
- Excessive oil carryover.
- Loss of evaporator performance due to oil level build-up in the low-pressure side of the system.

Failure to follow these instructions can result in equipment damage.

NOTE: Dispose of the oil waste appropriately.

Operation

Display Interface

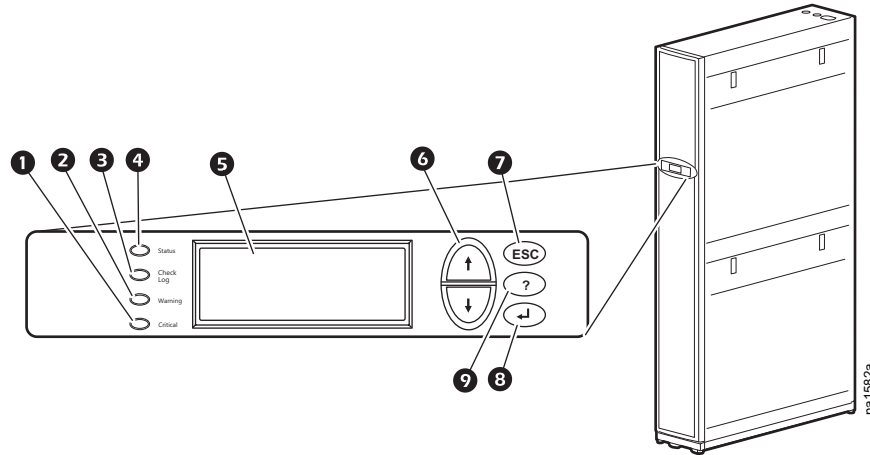

Item	Function
❶	Critical Alarm LED (red) When lit, a critical alarm condition exists and requires immediate attention.
❷	Warning Alarm LED (yellow) When lit, a warning alarm condition exists. Failure to correct this condition could cause a critical alarm.
❸	Check Log LED (yellow) When lit, at least one new event has been logged since the last time the log was checked. Only events that pertain to the operation of the cooling unit will activate the LED.
❹	Status LED (green) When lit, the cooling unit is receiving electrical power. When flashing green, the cooling unit is downloading firmware for the controller. Downloads may take up to ten minutes.
❺	Liquid Crystal Display (LCD) View alarms, status data, and context-sensitive help. Modify configurable settings.
❻	Up and down arrow keys Select menu items and access information.
❼	ESC key Return to previous screen or cancel current operation.
❽	Enter key Open menu items and input changes to cooling group level and cooling unit level settings.
❾	Help key Display context-sensitive help. Press the help key for information about each option on the screen and for instructions on performing tasks.

Using the Display Interface

Every time power is applied to the cooling unit, the display interface initializes, causing the LEDs to cycle and the alarm-tone to activate.

Scrolling status screens

After start-up, the interface displays the firmware revision number on the display interface. The display interface then scrolls automatically and continuously through screens of status information.

Status Screen Name	Status Information Displayed
InRow RD	<ul style="list-style-type: none"> • On/Standby/Idle/Service • User Defined Name • User Defined Location
Group	<ul style="list-style-type: none"> • Alarms/No Alarms • Cool Output kW • Cool Setpoint °C (or °F) • Maximum Rack Temperature °C (or °F)
Unit	<ul style="list-style-type: none"> • Alarms/No Alarms • Cool Output kW • Air Flow l/s (liters per second) or CFM (cubic feet per minute) • Rack Inlet °C (or °F)

Press the up or down arrow key to interrupt the automatic scrolling and view a specific status screen. From a main menu screen, press ESC to return to the scrolling status screens.

Main menu screens

On any top-level status screen, press the ENTER or ESC key to open the first main menu screen.



For information on setting the time-out duration, see "Timeout:" on page 27.

NOTE: Once a period of inactivity - at the display interface - exceeds the **Password Timeout** setting, the display interface returns to the scrolling status screens.

All main menu choices are displayed on a series of six main menu screens.

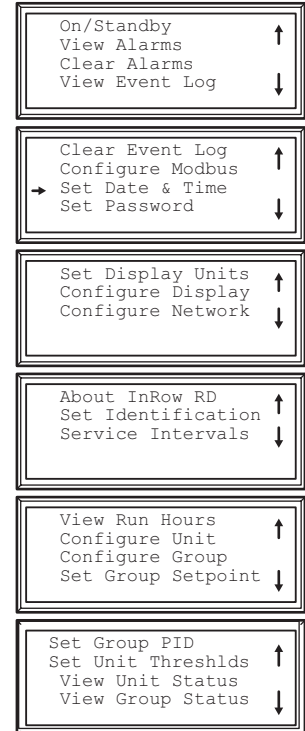

na1636d

Navigating the main menu

Selector arrow: Press the up or down arrow key to move the selector arrow ❶ to a main menu option. Press the ENTER key to view the selected sub-menu screen. In the example shown below, the selector arrow points to the **Set Date and Time** setting. To select that item, press the ENTER key.

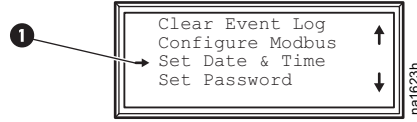

NOTE: If the selector arrow is on the top line of a main menu screen, press the up arrow key to move the selector arrow to the top line of the previous screen.

Continue arrows: Continue arrows ❷ indicate that additional options or settings are available on a menu or status screen. Press the up or down arrow key to view the additional items.

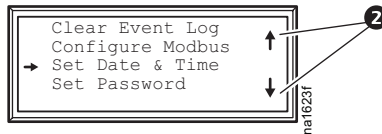

Navigating the sub-menus

Selecting a main menu option displays the sub-menu screen for that option. In this example, the selector arrow is on the top line of the **Set Date and Time** sub-menu screen.

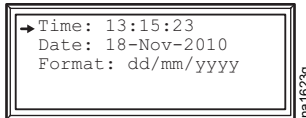

Use the up or down arrow key to move the selector arrow to an option, and press the ENTER key.

- **List of choices.** If the setting is a list of choices, an input arrow ❸ displays next to the setting. Press the up or down arrow key to select the menu option to change. Then press the ENTER key to exit the input mode and save the setting. Press the ESC key to exit without saving.
- **Numbers or text fields.** If the setting is a number or text field, use the arrow keys to select the value of the first character, and press the ENTER key to move to the next character. Press the ENTER key after the last character is set to exit the input mode and save the setting. Press the ESC key to exit without saving. If an invalid value is entered, the display interface beeps and restores the previous valid value to the field.

Input arrows: Input arrows ❸ next to a selected setting indicate that the setting can be modified by pressing the up or down arrow key. Press the ENTER key to save the change or the ESC key to cancel the change.

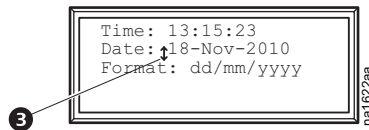

Using the Path statement

Select the main- and sub-menu options specified in the path statement to view or configure a setting. The path statement lists the main- and sub-menu items you select to navigate to the item to view or modify. The parts of the path statement are defined below:

Path: Main > Set Password > Change Passwords

Main: Your starting point is the main menu.

Set Password: Scroll to and select this option from the main menu.

Change Passwords: Scroll to and select this option from the sub-menu.

Subsequent options are listed and defined under the path statement.

Password entry

The cooling unit has two levels of password protection:

- **Device password** allows Device Users to change basic and environmental settings.
- **Admin password** allows all privileges granted for Device Users, and also allows the Administrator to modify settings that control the components in the cooling unit or change advanced options.

When you try to change a setting, the display interface prompts you to enter your Admin password. The default value for both the Device and Admin password is **apc** (lowercase). To enter your password, use the up or down arrow key to scroll through the available character set. Press the ENTER key to select the current character and move the cursor to the next character position. After selecting the last character of your password, press the ENTER key once more to submit your password.

Once the password is entered, it remains in effect until the period of inactivity exceeds the **Password Timeout** setting.



See "Timeout:" on page 27.

NOTE: Passwords are case-sensitive.

Start the cooling unit

Path: Main > Operation > On/Standby

1. To start the cooling unit, press the ENTER key until the cursor is on the **Operation > On/Standby** menu item.
2. Press the ENTER key again to show the toggle state arrow to the right of **Operation**.
3. Use the up and down arrow keys to change from **Standby** to **On**.



See “Path: Main > Operation > Limit Access” below if you are prompted to enter a password before changing the On/Standby setting.

4. Press the ENTER key again to set the **On** position.
 - a. The fans will start.
 - b. The cooling unit will run according to the configured settings.

NOTE: On/Standby only affects the local cooling unit. You must set the **On/Standby** option for each cooling unit in the cooling group.

Path: Main > Operation > Limit Access

The default setting for the **Limit Access** password protection option is **No**. If the Limit Access option has been set to **Yes**, you will be prompted to enter the Device password before a change can be made to the **On/Standby** setting.

Stop the cooling unit

Path: Main > Operation > On/Standby

1. To stop the cooling unit, press the ENTER key until the cursor is on the **Operation > On/Standby** menu item.
2. Press the ENTER key again to show the toggle state arrow to the right of **Operation**.
3. Use the up and down arrow keys to change from **On** to **Standby**.



See “Path: Main > Operation > Limit Access” above if you are prompted to enter a password before changing the **On/Standby** setting.

4. Press the ENTER key again to change the setting to **Standby**. The cooling unit will enter the standby mode.

⚠ ⚠ WARNING
ELECTRICAL HAZARD
The Standby option does not remove power from the cooling unit. You must disconnect power at the mains to remove power from the cooling unit.
Failure to follow these instructions can result in death, serious injury, or equipment damage.

General Configuration

The cooling group configuration options are set during the commissioning of the cooling units in the cooling group.

NOTE: All changes to settings must be performed by qualified personnel.

Cooling unit configuration

Path: Main > Configure Unit > General

Use the **General** menu to set the start-up delay, idle on leak, and refrigerant fill settings.

Start-up Dly (Start-up Delay): The delay begins when the cooling unit is started and initialized. The cooling unit cannot begin operation until this delay expires. Use the start-up delay to restart equipment sequentially after a scheduled downtime or a power outage.

Idle on Fail: When set to **Yes**, the cooling unit will enter idle mode if the cooling unit is unable to supply conditioned air. Set to **No** to disable the cooling unit from entering idle mode if a Cooling Failure is detected.

Idle On Leak: When set to **Yes**, the cooling unit will enter idle mode if a Water Detection Fault activates. Set to **No** to disable the cooling unit from entering idle mode if a leak is detected.

NOTE: The leak sensor (Schneider Electric part number AP9325) is optional.

NOTE: There are three alarms that will cause the cooling unit to enter idle mode when **Idle On Fail** and **Idle on Leak** are set to **Yes**:

- Water Detection Fault
- Condensate Pump Fault
- Cooling Failure



See “Alarm messages and suggested actions” on page 31 for more information on alarms.

Refrig Fill: Set to **Start** to add refrigerant to the system. This setting turns on the compressor and sets the fans to maximum speed until the compressor suction pressure drops below 50 psi for two minutes, twenty minutes elapse, or the property setting is changed to **Abort**.

NOTE: The **Refrig Fill** setting is intended only for charging the unit with refrigerant.

Role Override: Set to **ON**, forces the cooling unit to be the Primary cooling unit in the group. Set to **Auto**, allows the system to choose the role of the cooling unit. Select **ON** if you have **Runtime Balancing** enabled and you DO NOT want a particular unit in the group to become a backup unit. See page 23 for more information.

Contacts

View the state of input and output contacts

Path: Main > Configure Unit > Discrete I/O

Each cooling unit supports a user-defined input contact and a user-defined output contact. Each contact monitors a sensor and responds to changes in the state of the sensor (open or closed).

Input State: Indicates the actual state of the input contact (**Open** or **Closed**). A cooling unit is **On** when the state is normal and in **Standby** when the state is not normal.

Output State: Indicates the actual state of the output contact (**Open** or **Closed**). An alarm will cause the output contact to change from the normal state.

OHE Input State: Indicates the actual state of the input contact (**Open** or **Closed**) for the Outdoor Heat Exchanger.

Edit the normal state of input and output contacts

Path: Main > Configure Unit > Discrete I/O > Normal State

Configure the input contacts to cause alarm conditions based on the user-defined normal state. Output contacts can map internal alarms and events to outside devices.

Input Norm: Set the normal state of the contact (**Open** or **Closed**). The cooling unit changes its operating mode to **Closed** when the actual state differs from the normal state.

Output Norm: Set the normal state of the contact (**Open** or **Closed**). If the state of an alarm or event mapped to this contact changes from the normal state, the contact also changes state.

Outpt Src: Define the type of output source (alarm), either **Any Alarm** or **Critical**, that causes the output to change from its normal state.

OHE In Norm: Set the normal state of the contact (**Open** or **Closed**) for the Outdoor Heat Exchanger.

Cooling Group Configuration

Use the cooling group configuration settings to add cooling units to the group and to define group operation. The system automatically assigns the state of **Backup** to units in the group. A unit whose **Role Override** setting is set to **ON** will automatically be set as a **Primary** cooling unit. A unit in the **Standby** or **Failed** state is not considered a potential backup unit. The system periodically reviews the state of the units to maintain the proper number of **ON** and **Backup** units. If no units are available to assign to the **Backup** role, then the **No Backup Units Available** alarm is initiated.

NOTE: This procedure is to be performed by qualified personnel only. The settings in the **Configure Group** menu are defined by Schneider Electric authorized personnel when the cooling group is commissioned.

Configure the cooling group

Path: Main > Configure Group

The **Configure Group** menu contains settings that identify the number of cooling units installed in this cooling group and the physical arrangement of those cooling units.

Num Units: Enter the number of cooling units in this cooling group. Up to 12 cooling units can be joined together to work as a single cooling group.

Type: Set the rack deployment strategy for the cooling units of this cooling group:

- **Spot:** The cooling unit is used as a stand-alone unit.
- **In-Row:** Air flow is not ducted. Hot-aisle air is cooled and the cooled-air supply is shared by all loads in the row.
- **RACS (Rack Air Containment System):** Air flow in the enclosure is controlled by a ducting system fitted to the enclosure.
- **HACS (Hot Aisle Containment System):** Air flow in the room is controlled by enclosing the hot air aisle. The loads share an enclosed common hot aisle.

Capacity Ctrl: Set the capacity control of the cooling unit:

- **Disc (Discrete):** The cooling unit operates as a room air conditioner. The evaporator fan speed will remain constant at the user setting and the compressor will cycle on and off to maintain the cool setpoint. **NOTE:** The **Disc** mode is only available in a **Spot** cooling configuration.
- **Prop (Proportional):** The cooling unit matches the cooling output to the load demand. This is accomplished using hot gas adjustment and fan speed control. Load demand is determined by the cool setpoint and the temperature sensor at the rear of the cooling unit (in **Spot** configurations) or the temperature sensor at the front of the load rack (in **In-Row** and **RACS** configurations).

Fan Cntrl: This selection allows air flow to be controlled automatically by the cooling unit or manually by user-selected fan speed preference. This property only applies to **Spot** (Proportional), **InRow**, **RACS** and **HACS** deployments.

- **Auto:** Air flow is automatically controlled by the unit.
- **Manual:** the air flow is fixed to the value of the **Fan Speed Preference** property. See page 24 for more information.

Availability: Redundancy, Runtime Balancing, and Assist modes are only supported in Spot, HACS and RACS configurations.

- **Backup Units:** The cooling unit is not running but is ready to run if a unit fails, is unable to cool or needs cooling assistance.
- **Load Asst (Load Assist):** The unit was previously in the **Backup** mode but is now running due to a request for cooling assistance. When the assistance is no longer needed, the unit will return to the

Backup state. If a failure occurs on a cooling unit while the backup unit is assisting, the backup unit will take over for the failed cooling unit.

- **Runtm Bal (Runtime Balancing):** The system will maintain similar runtimes between units in the group. When the difference between the runtime hours of the cooling units in the system exceeds 72 hours, the system will automatically exchange modes between the longest running Primary cooling unit and the Backup with the least Runtime hours.

NOTE: The Runtime Balancing cap is not adjustable.

Runtime hours are hours that the cooling unit is actually operating and **NOT** 72 consecutive hours (three days) of time.

Identify the cooling unit

Path: Main > Set Identification

The **Set Identification** menu contains settings that identify the name and location of the cooling unit.

Name: Assign a **Name** of up to 40 alpha-numeric characters to this cooling unit.

Location: Enter the **Location**, up to 40 alpha-numeric characters, of the cooling unit.

NOTE: Only the first 19 characters (of the 40 that are possible to enter) will display on the display interface. You must use Telnet, the Control console or the Web to access all 40 characters. See page 38 for more information.

Configure Modbus

Path: Main > Configure Modbus

Use the **Configure Modbus** menu to set up communication between the cooling unit and the building management system.

Modbus: **Enable** or **Disable** the Modbus communication protocol.

Target Id: Each Modbus device must have a unique target identification number. Enter a unique number, from 1 to 247, for this cooling unit.

Baud Rate: Select either 9600 bps or 19200 bps.

Fixed settings: 8 data bits, no parity, 1 stop bit. These settings cannot be modified.

Control the Environment

The primary function of the cooling unit is to capture the heat generated by IT equipment and neutralize it before it mixes with the room. The control strategies employed by the cooling unit depend upon the deployment strategy of the cooling group.

In an InRow environment, the cooling unit supplies constant-temperature supply air to the common cold aisle. The fan speed is modulated to ensure that the required volume of air reaches the IT equipment. The fan speed is determined by the difference between the cooling setpoint and the maximum rack air inlet temperature of the cooling group.

In a HACS or RACS environment, the cooling unit neutralizes the heat accumulated in the common hot aisle and expels it into the surrounding environmental space while maintaining the necessary temperature difference across the IT equipment.

In a Spot cooling environment, the equipment operates like traditional CRAC equipment, providing a constant return air temperature. In **Discrete** mode, the fans operate at a user-selectable speed (**Fan Speed Preference**) and the compressor operates at maximum capacity. In **Prop** (Proportional) mode, the fans are modulated to maintain the required return air temperature and the compressor output is modulated to maintain the necessary supply air temperature.

Setpoints

Path: Main > Set Group Setpoint

A setpoint is the target value that a cooling group will maintain. The default setpoints are appropriate for most cooling applications.

The setpoints for each mode must be within the following ranges:

- **Cool:** 18.0 – 32.2°C (64.4 – 90°F)
- **Deadband:** 0 – 10.1°F
- **Supply Air:** 13.8 – 21.0°C (57 – 69.8°F) Spot (Proportional) only
15 – 21.0°C (59 – 69.8°F) HACS, RACS or InRow

NOTE: The **Supply Air** setting is defined by Schneider Electric authorized personnel only when the cooling group is commissioned.

NOTE: The **Supply Air** setpoint must never be set higher than the **Cool** setpoint.

- **Fan Speed:** When the unit is programmed for **HACS** or **RACS** mode, this property specifies the necessary temperature difference (DT) across the IT equipment. When the cooling unit is programmed for **Spot** (Proportional), **InRow**, **HACS** or **RACS** with the **Fan Control** property set to **Manual**, this property defines the fan speed. When the cooling unit is programmed for **Spot** (Discrete), the fan speeds are also selected from the following table but the **Fan Control** property is irrelevant.
 - **Low:** 16.7°C (30°F) DT (60% of maximum fan speed)
 - **Med-Low:** 13.9°C (25°F) DT (70% of maximum fan speed)
 - **Med:** 11.1°C (20°F) DT (80% of maximum fan speed)
 - **Med-High:** 6.3°C (15°F) DT (90% of maximum fan speed)
 - **High:** 5.6°C (10°F) DT (100% of maximum fan speed)

PID settings

Path: Main > Set Group PID

The Proportional plus Integral plus Derivative (PID) loop controls the output of the fans.

NOTE: This procedure is to be performed by Schneider Electric authorized personnel only. Improperly set PID controls could result in equipment damage.

There are two sets of PID coefficients stored in the unit. One set is used when the unit is programmed for **Spot** (Proportional) mode and the other set is used when the cooling unit is programmed for **InRow** mode. Only one set can be active at a time. The active PID set is determined by the value of the **Type** and **Capacity Ctrl** properties (**Path: Main > Configure Group**). The active set can be read, written or set to default.

Gain (P): The proportional multiplier (gain) for this mode or actuator. The proportional multiplier adjusts for the difference (error) between the measured value and the setpoint.

Rate (I): The integral multiplier (reset rate) for this mode or actuator. The integral multiplier adjusts for error measurement and the amount of time that the error has existed. The integral multiplier adds to or subtracts from the output in small increments to correct for the offset error caused by the proportional contribution.

Deriv (D): The derivative multiplier (derivative) for this mode or actuator. The derivative multiplier adjusts the output for rapid changes in the error, correcting for the rate of change of the error over time.

Reset to Deflts (InRow or Spot (Proportional) only): The **Gain**, **Rate** and **Derivative** coefficients return to their default values.

Tune the PID loop

Tune the PID loop to optimize the performance of the cooling group.

NOTE: This procedure is to be performed by Schneider Electric authorized personnel only. The PID loop must be tuned after the equipment in the room is installed and running. The loop should be tuned periodically to account for changes in the room load.

1. Adjust the integral and derivative constants to zero and the proportional constant to 1.0.
2. Set the temperature setpoint value and start the cooling group.
3. When the temperature reaches a stable value, increase the proportional constant by 0.5. If the temperature does not respond to this change, adjust the setpoint.
4. Repeat step 3 until the temperature value starts to oscillate and the peak amplitude of the oscillations is constant.
5. Note the time, in minutes, between the peaks of the oscillations. This is the Ultimate Period, P_U .
6. Note the value of the proportional constant. This is the Ultimate Gain, G_U .
7. Compute the PID constants using the table below. Use the equations for that control method in the row to compute the values for each constant.

Control Method	Proportional	Integral	Derivative
P	$0.5 * G_U$	–	–
P + I	$0.45 * G_U$	$0.54 * G_U / P_U$	–
P + I + D	$0.6 * G_U$	$1.2 * G_U / P_U$	$0.075 * G_U * P_U$

8. Set each constant according to these calculations.

You may need to further tune the PID loop in the following ways to account for changes in the room load:

Loop Behavior	PID Tuning Correction
Slow response to temperature changes	Increase the proportional multiplier or increase the derivative multiplier.

Loop Behavior

PID Tuning Correction

Overcooling/undercooling after changes in the room load or changes in setpoint	Increase the derivative or the proportional multiplier.
Environmental temperature never reaches the setpoint	Increase the integral multiplier.
Overcooling/undercooling on constant room load	Decrease the integral multiplier.

Run hours

The cooling unit records the number of hours each of its components has operated. When a component is replaced, use the **Reset Run Hours** option to reset the run hours for the displayed component to zero.

Path: Main > View Run Hours

- **Air Filter**
 - Reset Run Hours

NOTE: Replace air filters with Schneider Electric part number 875-2013 only.
- **Fans**
 - Fan Number
 - Reset Run Hours
- **Compressor**
 - Reset Run Hours
- **Condensate Pump**
 - Reset Run Hours
- **Fan Power Supplies**
 - Reset Run Hours

Thresholds

Set alarms to alert you to threshold violations.

Path: Main > Set Unit Thresholds

When the monitored input exceeds the unit threshold, an alarm occurs. Set high temperature thresholds for the following sensors:

- **Rack Inlet:** The temperature of the air entering the rack at the rack inlet sensors
- **Supply Air:** The average temperature of the air output from the cooling unit as measured between the upper and lower supply air temperature sensors.
- **Return Air:** The temperature of the air entering the cooling unit at the temperature sensor

Service intervals

Path: Main > Service Intervals

The air filters should be serviced regularly. The service interval depends on environmental cleanliness.

- **Air Filter Interval:** Set the number of weeks before service is required for the **Air Filter Interval**. The default is 18 weeks.
- **Alarm:** The interval setting has an alarm (**Enable** or **Disable**). If enabled, an audible alarm activates when the interval has elapsed. The alarm is cleared by selecting **Clear Alarms** in the main menu.

NOTE: The **Air Filter** interval alarm is enabled by default.

Display Settings

Set display interface settings including the time and date, units of measure, passwords, and time-out settings. You can also adjust the contrast, key click, beeper volume, and beep-on-alarm settings.

Password and time-out

Path: Main > Set Password

NOTE: The default user password is **apc** (lowercase). See "Password entry" on page 18 for information on passwords.

Change passwords: Set the Admin and Device passwords.

1. Move the selector arrow next to the **Change Passwords** option and press the ENTER key.
2. Select the password to change (either **Admin** or **Device**).
3. Enter a new password (up to 8 characters).
4. Press the ENTER key to confirm.

Timeout: Set the length of time which can elapse when no keys are pressed before the display interface returns to the scrolling screen status. The password must then be entered to regain access.

Invalidate Now: Override the password timeout and require password entry immediately.

Date and time

Path: Main > Set Date & Time

Set the time: Enter the correct time, and press the ENTER key. The **Time** setting is displayed on some status screens and is also used in the alarm/event log to time-stamp events.

Set the date: Enter the day, month, and year, and press the ENTER key. The **Date** setting is displayed on some status screens and is also used in the alarm/event log to date-stamp events.

Set the format: Use the up or down arrow key to select the date **Format** setting.

- mm/dd/yyyy (11/16/2007) (Default)
- yyyy-mm-dd (2007-11-16)
- dd-mmm-yy (16-Nov-07)
- mmm-dd-yy (Nov-16-07)
- dd.mm.yyyy (16.11.2007)

Adjust display settings

Path: Main > Configure Display

Contrast: Adjust the visibility of the screen text. Lower numbered settings provide darker text; higher numbers provide lighter text. Settings range from 0–7.

Key Click: Set to **ON** or **OFF** will enable or disable an audible tone that sounds every time a key is pressed on the display interface.

Beeper Volume: Set the volume (**Low**, **Medium**, **High** or **OFF**) of the audible tone that sounds every time a key is pressed on the display interface.

Beep on Alarm: Set to **ON** or **OFF**. When set to **ON**, the cooling unit will sound an audible tone every 30 seconds when a new alarm occurs. Silence the audible tone by pressing any key on the display interface. When the alarm clears itself, the tone will stop on its own.

Display units

Path: Main > Set Display Units

Set the units of measure for the cooling unit to either **US** or **Metric**.

Network Configuration

The cooling unit is shipped with a Network Management Card that enables the cooling unit to be managed over a network. Configure the network settings for the Network Management Card for this cooling unit from the display interface. The management card allows remote control and configuration of the equipment.

Configure network

Path: Main > ConfigureNetwork

MAC Address: Displays the unique network identifier which was assigned to the Network Management Card of this cooling unit at the factory.

Boot Mode: Set the method by which the Network Management Card of the cooling unit acquires network settings.

- **Manual:** Enter the IP address, subnet mask, and default gateway using the **IP Address** menu.
- **BOOTP:** Set the Network Management Card of the cooling unit to obtain its network settings from a BOOTP server.
- **DHCP:** Set the Network Management Card of the cooling unit to obtain its network settings from a DHCP server.



By default, DHCP requires a cookie before it will accept an IP address. See “BOOTP & DHCP configuration” on page 35 for more information.

- **BOOTPDHCP:** Set the Network Management Card of the cooling unit to search for its network settings from either a BOOTP or a DHCP server.

IP Address: You will be prompted to enter an Admin password. Enter the password and press **ENTER** to return to the **IP** screen. Press **ENTER** again to change the network settings for **Manual** boot mode only.

- **IP:** Enter the IP address assigned to the Network Management Card of this cooling unit.
- **SM:** Enter the subnet mask for the Network Management Card of this cooling unit.
- **GW:** Enter the default gateway for the Network Management Card of this cooling unit.

View Status Readings

The display interface has several options for viewing the status of the cooling unit, the cooling group to which the cooling unit belongs, and the environment being controlled. The status readings for the cooling unit are available under the **View Unit Status** option in the main menu, and status readings for the cooling group are available under the **View Group Status** option on the main menu or on the scrolling status screens.

Scrolling status screens

When the display interface is idle, it scrolls through screens of status information. Press the up or down arrow key to interrupt the automatic scrolling and view a specific status screen.

Cooling unit status

Path: Main > View Unit Status

The cooling unit status screens contain information specific to this cooling unit.

Op Mode: The cooling unit is in one of the following modes:

- **On:** The cooling unit is cooling.
- **Standby:** The cooling unit is receiving power but not enabled for cooling.
- **Idle:** The cooling unit is not operating in normal mode due to active critical alarms.



For more information, see “Idle on Fail:” on page 20.

Cool Output: The actual cooling output of the cooling unit.

Cool Demnd: The amount of cooling that the rack currently requires.

Rack Inlet: The temperature of the air entering the rack.

Supply Air: The temperature of the air leaving the cooling unit.

Return Air: The temperature of the air entering the cooling unit.

Fan Speed: The speed of the fans that regulate the air flow through the cooling unit.

Suction Temp: The temperature of the refrigerant in the suction line of the compressor.

Air Flow: The rate of air moved by the cooling unit.

Filter DP: The air filter differential pressure.

Input State: The state of the input contact.

Output State: The state of the output contact.

OHE Input St: The state of the input contact that controls the Outdoor Heat Exchanger.

OHE Output St: The state of the output contact that controls the Outdoor Heat Exchanger.

Suction: The suction pressure of the compressor.

Discharge: The discharge pressure of the compressor.

Superheat: The superheat temperature of the compressor.

Compressor: The state of the compressor (On/Off).

Cooling group status

Path: Main > View Group Status

View information about the cooling group.

Cool Output: The combined output of the cooling group.

Cool Demand: The cooling output required to meet the current heat load of the conditioned space.

Cool Setpt: The temperature you set to maintain the room environment.

Air Flow: The combined airflow output of the cooling units in the cooling group.

Max Rack: The highest rack temperature reported by any cooling unit in the cooling group.

Min Rack: The lowest rack temperature reported by any cooling unit in the cooling group.

Max Return: The highest return temperature reported by any cooling unit in the cooling group.

Min Return: The lowest return temperature reported by any cooling unit in the cooling group.

About the cooling unit

Path: Main > About InRow RD

View identifying information that is helpful when obtaining service:

- **Model:** Model number
- **S/N:** Serial number
- **F/W:** Firmware revision
- **H/W:** Hardware revision
- **Made:** Date of manufacture
- **APP Ver:** Application version
- **AOS Ver:** Operating System version

Event Log

The event log saves status information and a message each time a change in the cooling group is detected. Alarms and events are recorded in the log and displayed on the active alarms screen. Status information and system configuration changes are displayed in the event log only.

View the event log

Path: Main > View Event Log

The event log keeps a record of all alarms and events. The screen displays the following information:

- The name of the event
- The time and date the event occurred

Use the arrow keys to scroll through the list of events and display the date and time for each event.

Clear the event log

Path: Main > Clear Event Log

A confirmation screen displays when this option is selected. Enter the Admin password to erase the log. Select **YES** to erase all of the events in the log. Select **NO** to return to the main screen.

Respond to Alarms

When an alarm is triggered, the cooling unit alerts you through the display interface by the following methods:

- Active alarm screen entry on scrolling status screens
- LEDs on the front panel display
- An optional audible alarm, if enabled, every 30 seconds

View active alarms

Path: Main > View Alarms

The **View Alarms** screen provides the number of alarms, the severity level of each active alarm, and a brief description of each alarm. Press the arrow keys to view the rest of the list.

Clear active alarms

Path: Main > Clear Alarms

A confirmation screen displays when this option is selected. Enter the Admin password to clear the alarm list. Select **YES** to clear all of the alarms in the list. Select **NO** to return to the main screen. If the conditions that caused the alarm still exist, those conditions will cause the alarm to be regenerated.

Alarm messages and suggested actions

Alarm Message	Severity	Action Required
Cool Fail	Critical	• A hardware failure exists. For assistance, contact Schneider Electric technical support.
High Rack Temp (Rack Temperature High Violation)	Critical	• Make sure the temperature sensors are located properly. • If the problem persists, replace the sensor or contact Schneider Electric technical support.
Air Fltr Clogged (Air Filter Clogged)	Warning	• Clean or replace the air filter. • If the problem persists, contact Schneider Electric technical support.
Rtn Air Snsr Fault (Return Air Sensor # Fault)	Critical	• Make sure the temperature sensor is connected properly. • If the problem persists, contact Schneider Electric technical support.
Sply Air Snsr Fault (Supply Air Sensor # Fault)	Critical	• Make sure the temperature sensor is connected properly. • If the problem persists, contact Schneider Electric technical support.
Rack Temp Snsr Fault (Rack Temperature Sensor Fault)	Critical	• Make sure the temperature sensor is connected properly. • If the problem persists, contact Schneider Electric technical support.
High Dischrg Pres (High Discharge Pressure)	Critical	• Check the condenser for obstructions. • If the problem persists, contact Schneider Electric technical support.
Low Suction Pres (Low Suction Pressure)	Warning	• Check the air filter and fans for obstructions. • For assistance, contact Schneider Electric technical support.
High Suction Pres (High Suction Pressure)	Warning	• If the problem persists, contact Schneider Electric technical support.

Alarm Message	Severity	Action Required
Fan Num Fault (Fan # Fault)	Warning	<ul style="list-style-type: none"> • A hardware failure exists. For assistance, contact Schneider Electric technical support.
Water Detected	Warning	<ul style="list-style-type: none"> • Identify the source of the leak. Water could be from the condensate pump, condensate carryover from the evaporator, or condensation. • For assistance, contact Schneider Electric technical support.
Conds Pump Fault (Condensate Pump Fault)	Warning	<ul style="list-style-type: none"> • A hardware failure exists. For assistance, contact Schneider Electric technical support.
Pan Full (Condensate Pan Full Fault)	Critical	<ul style="list-style-type: none"> • Empty the pan and make sure the drain line is not clogged. • If the problem persists, contact Schneider Electric technical support.
Fan PwrSp Fault (Upper Fan Power Supply Fault)	Warning	<ul style="list-style-type: none"> • Make sure the power supplies are seated properly and the Input and Output Healthy LEDs are lit. • If the problem persists, contact Schneider Electric technical support.
Fan PwrSp Fault (Lower Fan Power Supply Fault)	Warning	<ul style="list-style-type: none"> • Make sure the power supplies are seated properly and the Input and Output Healthy LEDs are lit. • If the problem persists, contact Schneider Electric technical support.
Air Fltr RnHr Violation (Air Filter Run Hours Violation)	Warning	<ul style="list-style-type: none"> • Reset the Air Filter Run Hours after the air filter is cleaned or replaced.
Grp Comm Fault (Group Communication Fault)	Warning	<ul style="list-style-type: none"> • Make sure the number of cooling units in the group is configured properly and the A-Link connections between cooling units are correct. • Make sure the system is receiving power and is connected properly. • A hardware failure exists. For assistance, contact Schneider Electric technical support.
Sply Air High Temp (Supply Air High Temperature Violation)	Warning	<ul style="list-style-type: none"> • Make sure the Supply Air threshold is set correctly in the Set Unit Thresholds screen. • If the problem persists, contact Schneider Electric technical support.
Rtn Air High Temp (Return Air High Temperature Violation)	Warning	<ul style="list-style-type: none"> • Make sure the Return Air threshold is set correctly in the Set Unit Thresholds screen. • If the problem persists, contact Schneider Electric technical support.
Filter DP Sensor Failure	Warning	<ul style="list-style-type: none"> • Make sure the sensor is connected properly. • If the problem persists, replace the sensor or contact Schneider Electric technical support.
Suction Temperature Sensor Failure	Warning	<ul style="list-style-type: none"> • Make sure the sensor is connected properly. • If the problem persists, replace the sensor or contact Schneider Electric technical support.
Suction Pressure Sensor Failure	Warning	<ul style="list-style-type: none"> • Make sure the sensor is connected properly. • If the problem persists, replace the sensor or contact Schneider Electric technical support.

Alarm Message	Severity	Action Required
Dischrg Pressure Sensor Failure	Warning	<ul style="list-style-type: none"> • Make sure the sensor is connected properly. • If the problem persists, contact Schneider Electric technical support.
Input Contact Fault	Warning	<ul style="list-style-type: none"> • Make sure the Input Normal state is defined correctly in the Configure Unit> Discrete I/O screen. See page 21 for more information. • Clear the problem that caused the input contact switch to change from the normal state. • If the problem persists, contact Schneider Electric technical support.
Persistent High Discharge Pressure Fault	Critical	<ul style="list-style-type: none"> • Indicates there were three High Discharge Pressure shutdowns in 30 minutes. Alarms must be cleared manually. • If the problem persists, contact Schneider Electric technical support.
Persistent Low Suction Pressure Fault	Critical	<ul style="list-style-type: none"> • Indicates there were 3 Low Suction Pressure shutdowns in 30 minutes. Alarms must be cleared manually. • If the problem persists, contact Schneider Electric technical support.
Rack Inlet (Rack Inlet Temperature High Threshold)	Critical	<ul style="list-style-type: none"> • Make sure the Rack Inlet setting is correct in the Set Unit Thresholds screen. • If the problem persists, contact Schneider Electric technical support.
Supply Air (Supply Air Temperature High Threshold)	Critical	<ul style="list-style-type: none"> • Make sure the Supply Air setting is correct in the Set Unit Thresholds screen. • If the problem persists, contact Schneider Electric technical support.
Return Air (Return Air Temperature High Threshold)	Critical	<ul style="list-style-type: none"> • Make sure the Return Air setting is correct in the Set Unit Thresholds screen. • If the problem persists, contact Schneider Electric technical support.
No Backup Units Available	Warning	<ul style="list-style-type: none"> • Check to make sure cooling units in the group are set to Configure Unit > General > Role Override > Auto and that cooling units are available (not in a failed state). • For assistance, contact Schneider Electric technical support.

Network Management Card

Quick Configuration

The cooling unit is shipped with a Network Management Card that enables the cooling unit to be managed over a network. Configure the Network Management Card to control this cooling unit through a network.

Overview

You must configure the following TCP/IP settings before the Network Management Card can operate on a network:

- IP address of the Network Management Card
- Subnet mask
- Default gateway

IMPORTANT: Never use the loopback address (127.0.0.1) as the default gateway address for the Network Management Card. Doing so will disable the card and will require you to reset TCP/IP settings to their defaults using a local serial login.

NOTE: If a default gateway is unavailable, use the IP address of a computer that is located on the same subnet as the Network Management Card and that is usually running. The Network Management Card uses the default gateway to test the network when traffic is very light.



See “Watchdog Features” in the “Introduction” of the *User Guide* for more information about the watchdog role of the default gateway.

TCP/IP configuration methods

Use one of the following methods to define the basic TCP/IP settings needed by the Network Management Card:

- Device IP Configuration Wizard (See “Device IP Configuration Wizard” on page 35.)
- BOOTP or DHCP server (See “BOOTP & DHCP configuration” on page 35.)
- Networked computer (See “Remote access to the control console” on page 36.)

Device IP Configuration Wizard

You can use the Device IP Configuration Wizard at a computer running Microsoft® Windows® 2000, Windows® Server 2003, or Windows® XP to configure a Network Management Card.

NOTE: Most software firewalls must be temporarily disabled for the Wizard to discover unconfigured Network Management Cards.



To configure one or more Network Management Cards from a user configuration file, see the *User's Guide* on the *Utility CD*.

1. Insert the *Utility CD* into a computer on your network.
2. If autorun is enabled, the user interface of the CD starts when you insert the CD. If autorun is not enabled, open the file **contents.htm** on the CD.
3. When the Wizard discovers the unconfigured Network Management Card, follow the on-screen instructions.

NOTE: If you leave the **Start a Web browser when finished** option enabled, you can use **apc** for both the user name and password to access the Network Management Card through your browser.

.ini file utility

You can use the .ini file export utility to export .ini file settings from configured Network Management Cards to one or more unconfigured Network Management Cards. The utility and documentation are included on the *Utility CD*.

BOOTP & DHCP configuration

The default TCP/IP configuration setting, **BOOTP & DHCP**, assumes that a properly configured BOOTP or DHCP server is available to provide TCP/IP settings to Network Management Cards. The Network Management Card first attempts to discover a properly configured BOOTP server, and then a DHCP server. It repeats this pattern until it discovers a BOOTP or DHCP server.



If neither of these servers is available, see “Local access to the control console” on page 36 or “Remote access to the control console” on page 36 to configure the needed TCP/IP settings.



A user configuration (.ini) file can function as a BOOTP or DHCP boot file. For more information, see the TCP/IP configuration section of the *User's Guide*, available from the *Utility CD* or the Schneider Electric Web site, www.schneider-electric.com.

BOOTP: For the Network Management Card to use a BOOTP server to configure its TCP/IP settings, it must find a properly configured RFC951-compliant BOOTP server.

1. In the BOOTPTAB file of the BOOTP server, enter the MAC address of the Network Management Card, the IP address, the subnet mask, default gateway, and an optional boot-up file name. Look for the MAC address on the display interface (**Path: Main > Configure Network**) or on the label on the back of the Network Management Card.
2. When the Network Management Card reboots, the BOOTP server provides it with the TCP/IP settings.
 - If you specified a boot-up file name, the Network Management Card attempts to transfer that file from the BOOTP server using TFTP or FTP. The Network Management Card assumes all settings specified in the boot-up file.
 - If you did not specify a boot-up file name, you can configure the other settings of the Network Management Card remotely through its Web interface or control console; user name and password are both **apc**, by default.



See your BOOTP server documentation to create a boot-up file.

DHCP: You can use a RFC2131/RFC2132-compliant DHCP server to configure the TCP/IP settings for the Network Management Card.



This section summarizes communication between the Network Management Card and a DHCP server. For more detail about how a DHCP server can configure the network settings for a Network Management Card, see “DHCP Configuration” in the *User Guide*.

1. A Network Management Card sends out a DHCP request that uses the following to identify itself:
 - A Vendor Class Identifier (APC by default)
 - A Client Identifier (by default, the MAC address value of the Network Management Card)
 - A User Class Identifier (by default, the identification of the application firmware of the Network Management Card)
2. A properly configured DHCP server responds with a DHCP offer that includes all of the settings that the Network Management Card needs for network communication. The DHCP offer also includes the Vendor Specific Information option (DHCP option 43). By default, the Network Management Card will ignore DHCP offers that do not encapsulate the cookie in the Vendor Specific Information option using the following hexadecimal format:

```
Option 43 = 01 04 31 41 50 43
```

where

- the first byte (01) is the code
- the second byte (04) is the length
- the remaining bytes (31 41 50 43) are the cookie



See your DHCP server documentation to add code to the Vendor Specific Information option.

To disable the requirement that a DHCP offer include the cookie, use the **DHCP Cookie Is** setting in the control console:

```
Network>TCP/IP>Boot Mode>DHCP only>Advanced>DHCP Cookie Is.
```

Local access to the control console

You can use a computer connected to the serial port on the main board holding the Network Management Card to access the control console.

1. Select a serial port at the local computer, and disable any service that uses that port.
2. Use the provided configuration cable to connect the selected port to the serial port on the main board holding the Network Management Card.
3. Run a terminal program (such as HyperTerminal) and configure the selected port for 9600 or 19200 bps, 8 data bits, no parity, 1 stop bit, and no flow control. Save the changes.
4. Press ENTER to display the **User Name** prompt.
5. Use **apc** for the user name and password.



See “Control console” on page 37 to finish the configuration.

Remote access to the control console

From any computer on the same subnet as the Network Management Card, you can use ARP and Ping to assign an IP address to a Network Management Card, and then use Telnet to access the control console of that Network Management Card and configure the needed TCP/IP settings.

NOTE: After the IP address of the Network Management Card is configured, you can use Telnet without first using ARP and Ping to access that Network Management Card.

1. Use the MAC address for the Network Management Card in the ARP command to define the IP address. For example, to define an IP address of 156.205.14.141 for a Network Management Card that has a MAC address of 00 c0 b7 63 9f 67, use one of the following commands:

– Windows command format:

```
arp -s 156.205.14.141 00-c0-b7-63-9f-67
```

– LINUX command format:

```
arp -s 156.205.14.141 00:c0:b7:63:9f:67
```

NOTE: The MAC address is available on the display interface at:

Path: Main > Configure Network or look at the label on the back of the Network Management Card for the MAC address.

1. Use Ping with a size of 113 bytes to assign the IP address defined by the ARP command. For the IP address defined in step 1, use one of the following Ping commands:

– Windows command format:

```
ping 156.205.14.141 -l 113
```

– LINUX command format:

```
ping 156.205.14.141 -s 113
```

2. Use Telnet to access the Network Management Card at its newly assigned IP address. For example:

```
telnet 156.205.14.141
```

3. Use **apc** for both user name and password.



See “Control console” on page 37 to finish the configuration.

Control console

After you log on at the control console, as described in “Local access to the control console” on page 36 or “Remote access to the control console” on page 36:

1. Choose **Network** from the **Control Console** menu.
2. Choose **TCP/IP** from the **Network** menu.
3. If you are not using a BOOTP or DHCP server to configure the TCP/IP settings, select the **Boot Mode** menu and then select **Manual boot mode**.
4. Set the **System IP**, **Subnet Mask**, and **Default Gateway** address values. (Changes will take effect when you log out.)
5. Press ENTER to return to the **TCP/IP** menu.
6. Press CTRL+C to exit to the **Control Console** menu.
7. Log out (option 4 in the **Control Console** menu).

NOTE: If you disconnected a cable from the local computer during the procedure described in “Local access to the control console” on page 36, reconnect that cable and restart the associated service.

Access a Configured Network Management Card

Overview

After the Network Management Card is running on your network, you can access the configured Network Management Card through the following interfaces:

- Web interface (HTTP or HTTPS protocol)
- Telnet or Secure SHell (SSH)
- SNMP
- FTP or Secure CoPy (SCP) to upgrade firmware
- Modbus



For more information on the interfaces, see the *User Guide*.

Web interface

Use Microsoft Internet Explorer® (IE) 5.5 and higher (on Windows operating systems only), Mozilla-based browsers that support Firefox® 1.x (on all operating systems), or Netscape® 7.x and higher (on all operating systems) to access the Web interface of the cooling unit. Other commonly available browsers also may work but have not been fully tested by Schneider Electric.

You can use either of the following protocols when you use the Web interface:

- The HTTP protocol (enabled by default), which provides authentication by user name and password but no encryption.
- The HTTPS protocol, which provides extra security through Secure Sockets Layer (SSL); encrypts user names, passwords, and data being transmitted; and authenticates the Network Management Card by means of digital certificates.

To access the Web interface and configure the security of your device on the network:

1. Address the Network Management Card by its IP address or DNS name (if configured).
2. Enter the user name and password (by default, **apc** and **apc** for an Administrator).
3. To enable or disable the HTTP or HTTPS protocols, use the **Network** menu on the **Administration** tab. Select the **access** option under the **Web** heading on the navigation menu.



For more information on selecting and configuring network security, see the *Security Handbook*, available from the Schneider Electric Web site, www.schneider-electric.com.

4.

Telnet and SSH

You can access the control console through Telnet or Secure SHell (SSH), depending on which is enabled. Select the **Administration** tab, the **Network** option on the top menu bar, and then the **access** option under **Console** on the left navigation menu. By default, Telnet is enabled. Enabling SSH automatically disables Telnet.

Telnet for basic access: Telnet provides the basic security of authentication by user name and password, but not the high-security benefits of encryption. To use Telnet to access the control console of the Network Management Card:

1. At a command prompt, use the following command line, and press ENTER:

```
telnet address
```

As *address*, use the IP address of the Network Management Card (or DNS name if configured).

2. Enter the user name and password (by default, **apc** and **apc** for an Administrator, or **device** and **apc** for a Device User).

SSH for high-security access: If you use the high security of SSL for the Web interface, use Secure SHell (SSH) for access to the control console. SSH encrypts user names, passwords, and transmitted data.

The interface, user accounts, and user access rights are the same whether you access the control console through SSH or Telnet, but to use SSH, you must first configure SSH and have an SSH client program installed on your computer.



See the *User Guide* for more information on configuring and using SSH.

Simple Network Management Protocol (SNMP)

SNMPv1 only: After you add the PowerNet® MIB to a standard SNMP MIB browser, you can use that browser to access the Network Management Card. All user names, passwords, and community names for SNMP are transferred over the network as plain text. The default read community name is **public**; the default read/write community name is **private**.

SNMPv3 only: For SNMP GETs, SETs, and trap receivers, SNMPv3 uses a system of user profiles to identify users. An SNMPv3 user must have a user profile assigned in the MIB software program to perform GETs and SETs, browse the MIB, and receive traps. The default settings are **no authentication** and **no privacy**.

NOTE: To use SNMPv3, you must have a MIB program that supports SNMPv3.

NOTE: The Network Management Card supports only MD5 authentication and DES encryption.

SNMPv1 and SNMPv3: To use StruXureWare Data Center Expert to manage the Network Management Card, you must have SNMPv1 enabled in the interface of the cooling unit. Read access allows InfraStruXure devices to receive traps from the cooling unit. Write access is required while you set the InfraStruXure device as a trap receiver.

To enable or disable SNMP access, you must be an Administrator. Select the **Administration** tab, select the **Network** menu on the top menu bar, and use the **access** option under **SNMPv1** or **SNMPv3** on the left navigation menu.

FTP/SCP

You can use FTP (enabled by default) or Secure CoPy (SCP) to transfer downloaded firmware to the Network Management Card, or to access a copy of the event or data logs of the cooling unit. SCP provides the higher security of encrypted data transmission and is enabled automatically when you enable SSH.

To use StruXureWare Data Center Expert to manage the Network Management Card, you must have **FTP Server** enabled in the Network Management Card. To enable or disable **FTP Server** access, you must be an Administrator. On the **Administration** tab, select the **Network** menu on the top menu bar, and use the **FTP server** option on the left navigation menu.



In the *User Guide*, see the following sections:

- To transfer firmware, see “File Transfers.”
- To retrieve a copy of the event or data log, see “Use FTP or SCP to retrieve log files.”

Modbus

Use Modbus to view the Network Management Card through the interface of your building management system. It is read-only.

The Modbus interface supports 2-wire RS-485, plus ground.

NOTE: Modbus can be configured to run at either 9600 or 19200 bps.



To access the Modbus register map, go to the Schneider Electric Web site, www.schneider-electric.com.

Recover From a Lost Password

You can use a local computer (a computer that connects to the Network Management Card through the serial port) to access the control console.

1. Select a serial port at the local computer, and disable any service that uses that port.
2. Connect the provided RS-232 configuration cable to the selected port on the computer and to the RS-232 console port at the Network Management Card.
3. Run a terminal program (such as HyperTerminal) on your computer and configure the selected port for 9600 or 19200 bps, 8 data bits, no parity, 1 stop bit, and no flow control.
4. Press ENTER, repeatedly if necessary, to display the **User Name** prompt. If you are unable to display the **User Name** prompt, verify the following:
 - The serial port is not in use by another application.
 - The terminal settings are correct as specified in step 3.
 - The correct cable is being used as specified in step 2.
5. Press the **Reset** switch. The Status LED will flash alternately orange and green. Press the **Reset** button a second time immediately while the LED is flashing to reset the user name and password to their defaults temporarily.
6. Press ENTER as many times as necessary to redisplay the **User Name** prompt, then use the default, **apc**, for the user name and password. (If you take longer than 30 seconds to log on after the **User Name** prompt is redisplayed, you must repeat step 5 and log on again.)
7. From the **Control Console** menu, select **System**, then **User Manager**.
8. Select **Administrator**, and change the **User Name** and **Password** settings, both of which are now defined as **apc**.
9. Press CTRL+C, log off, reconnect any serial cable you disconnected, and restart any service you disabled.

Maintenance

Monthly Preventive Maintenance

Photocopy the following pages and use them during the maintenance procedures. After they have been completed, save them for future reference.

Prepared By: _____

Model Number: _____

Serial Number: _____

Date: _____

Environment

In what type of room is the cooling unit located?

Is the cooling unit maintaining the temperature setpoint?

Temperature setpoint _____

Is there visible damage to the cooling unit (dents, scratches)?

Check for environmental damage (dirt, dust, debris, liquid stains) around the cooling unit installation area.

Record the room temperature near the air return of the cooling unit.

Temperature _____

Record the alarm history for the last month.

Cleanliness

Check the condition of the air filters. Clean or change if necessary.

Check for accumulation of debris in the drain pan. Clean as required.

Mechanical

⚠ ⚠ DANGER

HAZARD OF ELECTRIC SHOCK, EXPLOSION, OR ARC FLASH

- Apply appropriate personal protective equipment (PPE) and follow safe electrical work practices. See NFPA 70E or CSA Z462.
- This equipment must be installed and serviced by qualified personnel only.
- Turn off all power supplying this equipment before working on or inside the equipment.
- Always use a properly rated voltage sensing device to confirm power is off.
- Replace all devices, doors, and covers before turning on power to this equipment.

Failure to follow these instructions will result in death or serious injury.

-
- Check the fans. All components should be moving freely with no signs of binding or damages.
-
- Verify that the condensate line is flowing freely.
-

Electrical

⚠ ⚠ DANGER

HAZARD OF ELECTRIC SHOCK, EXPLOSION, OR ARC FLASH

- Apply appropriate personal protective equipment (PPE) and follow safe electrical work practices. See NFPA 70E or CSA Z462.
- This equipment must be installed and serviced by qualified personnel only.
- Turn off all power supplying this equipment before working on or inside the equipment.
- Always use a properly rated voltage sensing device to confirm power is off.
- Replace all devices, doors, and covers before turning on power to this equipment.

Failure to follow these instructions will result in death or serious injury.

-
- Inspect the electrical panel for tight connections and for overheated connections from loose contact terminals.
-
- Confirm that the incoming main power matches the rating listed on the nameplate of the cooling unit. The measurement should be within 10% of the nameplate listing.
-

Quarterly Preventive Maintenance

Perform all the Monthly Preventive Maintenance items **and** the items below.



Prepared By: _____

Model Number: _____

Serial Number: _____

Date: _____

Mechanical

  DANGER
HAZARD OF ELECTRIC SHOCK, EXPLOSION, OR ARC FLASH
<ul style="list-style-type: none">• Apply appropriate personal protective equipment (PPE) and follow safe electrical work practices. See NFPA 70E or CSA Z462.• This equipment must be installed and serviced by qualified personnel only.• Turn off all power supplying this equipment before working on or inside the equipment.• Always use a properly rated voltage sensing device to confirm power is off.• Replace all devices, doors, and covers before turning on power to this equipment.
Failure to follow these instructions will result in death or serious injury.

Verify that the fan hardware is tight.

Clean or replace the air filters.

Clean the condensate drain line.

Clean the dust from door perforations.

Clean the dust from fan bezels.

Functional tests

Verify the cooling operation mode is functioning properly.

Semi-Annual Preventive Maintenance

Perform all the Monthly/Quarterly Preventive Maintenance items **and** the items below.

Prepared By: _____

Model Number: _____

Serial Number: _____

Date: _____

Cleanliness

- Check the cleanliness of the evaporator coil. Clean if required.
-

Troubleshooting

Problem	Possible Cause	Corrective Action
Controls erratic or inoperative	<ul style="list-style-type: none"> • Inlet temperature to cooling unit is higher than rated maximum temperature 	<ul style="list-style-type: none"> • Reduce the load or add additional cooling equipment.
Fans fail to start	<ul style="list-style-type: none"> • Power supplies are not operating properly • Failed power supply • Cooling unit shutdown due to an external command • Single fan fails to start 	<ul style="list-style-type: none"> • Confirm that the power supplies are seated properly and fully engaged. This is indicated by a green LED. • Confirm that the cooling unit is plugged in and is receiving power. • Replace the power supply if the LED is red. • Temporarily remove the user contact cable, if it is connected. • Replace the fan.
Cooling unit cannot obtain setpoint	<ul style="list-style-type: none"> • Improper placement of remote temperature sensor • Dirty filter • Dirty coil • Application error • Heat load is too far away 	<ul style="list-style-type: none"> • Verify that the remote temperature sensor is properly located in the cold aisle. • Clean the filter. • Clean the coil. • For assistance, contact Schneider Electric technical support. • Place the cooling unit closer to the heat load.
Water carryover	<ul style="list-style-type: none"> • Improper fan speed selected 	<ul style="list-style-type: none"> • RACS and HACS modes only. Select the next highest fan speed setting. For example, change the fan speed setting from Low to Med/Low.
Temperature control not tight enough	<ul style="list-style-type: none"> • Improper placement of remote temperature sensor 	<ul style="list-style-type: none"> • Verify that the remote temperature sensor is properly located in the cold aisle.
Water on outside of cooling unit	<ul style="list-style-type: none"> • Condensate drain hose is not connected or not properly routed outside the cooling unit • Leak in piping system • Cooling unit not leveled properly • Damaged piping insulation 	<ul style="list-style-type: none"> • Verify that the condensate drain hose is properly connected to the pump and properly routed outside of the cooling unit. • Verify that the condensate drain line does not exceed 4.9 meters (16 feet) lift and 15.4 meters (50.0 feet) horizontal run. • Locate and repair the leak. • Adjust the leveling feet of the cooling unit. • Identify damaged area and repair the insulation.
Display interface not operational but cooling unit operates	<ul style="list-style-type: none"> • Display interface not connected properly 	<ul style="list-style-type: none"> • Verify that the display interface cable is connected properly.
Incorrect air pressure	<ul style="list-style-type: none"> • False filter clogs 	<ul style="list-style-type: none"> • Verify that the ends of the clear plastic air tubes are not obstructed. • Verify that the clear plastic air tubes are connected to the controller. • Verify that the clear plastic air tubes are not pinched.
Alarms do not show up on monitoring equipment (Customer Output Contact)	<ul style="list-style-type: none"> • External monitoring equipment is not receiving power or is not functioning properly 	<ul style="list-style-type: none"> • Confirm that power, if required, is being supplied to the external equipment. • If the cooling unit (+12 V or +24 V) is providing power to the external equipment, verify that the external equipment is ≤ 50 mA. • Test the external equipment by bypassing the output contact. • Verify Customer Output Contact settings. See “Contacts” on page 21.

Problem	Possible Cause	Corrective Action
Cooling unit does not shut down on command	<ul style="list-style-type: none"> • Drive voltage 	<ul style="list-style-type: none"> • Verify that there is a drive voltage entering the input of the cooling unit. You may use the available +12 V or +24 V. You must then also use the ground. • Verify Customer Input Contact settings. See “Contacts” on page 21.
No communication with building management system (BMS) port	<ul style="list-style-type: none"> • Improper connection 	<ul style="list-style-type: none"> • Confirm that the cooling unit is connected to the BMS port and not to the Control port. • Make sure that the wire polarity is correct. Using a DC voltmeter, test the signal with no transmissions in progress. Pin 2 should be greater than Pin 1 by at least 200 mV. Measure the cooling unit with the cable disconnected, and then measure it again with the cable connected. If the signal is less than 200 mV, the cooling unit may be reverse-wired. • Make sure that every cooling unit has either two sets of wires in its connector or one set of wires and a 100-ohm resistor (a terminating resistor of 100 to 120 ohms).
Cooling units are not communicating with each other	<ul style="list-style-type: none"> • A-Link failure 	<ul style="list-style-type: none"> • Verify the actual number of cooling units in the group matches the group number setting. • Verify that the A-Link ports of every cooling unit have either two cables or one cable and a terminator. • Confirm that the A-Link cables are connected to the A-Link ports and that a network cable is connected to the network port.
Output air is 17°C (62°F) and fans are running at a very high rate of speed.	<ul style="list-style-type: none"> • Upper or lower supply air sensor fault 	<ul style="list-style-type: none"> • Either the upper or lower supply air temperature sensor has a fault. Verify that both supply air temperature sensors are installed and working properly.

Worldwide Customer Support

Customer support for this or any other product is available at no charge in any of the following ways:

- Visit the Schneider Electric Web site to access documents in the Schneider Electric Knowledge Base and to submit customer support requests.
 - **www.schneider-electric.com** (Corporate Headquarters)
Connect to localized Schneider Electric Web sites for specific countries, each of which provides customer support information.
 - **www.schneider-electric.com/support/**
Global support searching Schneider Electric Knowledge Base and using e-support.
- Contact the Schneider Electric Customer Support Center by telephone or e-mail.
 - Local, country-specific centers: go to **www.schneider-electric.com > Support > Operations around the world** for contact information.

For information on how to obtain local customer support, contact the representative or other distributors from whom you purchased your product.

As standards, specifications, and designs change from time to time, please ask for confirmation of the information given in this publication.

© 2014 Schneider Electric. All Rights Reserved.

InRow and the Schneider Electric logo are trademarks owned by Schneider Electric Industries S.A.S., or its affiliated companies. All other trademarks are the property of their respective owners.