



**MICROPROCESSOR CONTROLLER
OPERATION AND MAINTENANCE
MANUAL
February 1, 2002**

This manual provides information for installation, operation and preventive maintenance. The user should observe the guidelines and procedures presented herein to promote satisfactory performance.

**American Power Conversion
132 Fairgrounds Road
West Kingston, RI 02892
Telephone: 800-800-4APC
Website: www.apc.com**

NOTICE

This controller is specifically designed for special applications described in this manual. It will provide years of service if it is installed, operated and maintained in accordance with these instructions. Damage to the unit from improper installation, operation or maintenance is not covered in the warranty.

STUDY the instructions contained in this manual. They must be followed to avoid difficulties. Spare parts are available from American Power Conversion, and it is the responsibility of the user to have an ample supply of parts available to ensure continuous unit operation. Using substitute parts or bypassing electrical components in order to continue operation is not recommended and will **VOID THE WARRANTY**.

The following are not manufacturing defects or results of manufacturing defects and are not covered by the American Power Conversion factory warranty; they are the responsibility of the owner:

- 1) Damage resulting from handling during installation or damage resulting from transportation.
- 2) Incorrect or fluctuating power supply.
- 3) Operation outside of the operating conditions as specified in this manual.
- 4) Inaccessibility of the unit for service or parts installation that prevents the equipment from operating with an adequate supply of air or water.
- 5) Damage resulting from the use of the unit in a corrosive atmosphere.
- 6) Damage by not cleaning or replacing filters.
- 7) Damage by accident, alteration of the unit design, or tampering.

FACTORY FIELD SERVICE

American Power Conversion maintains a competent technical service group to assist our customers in any maintenance, service or repair problems which might arise. For information regarding factory assistance, call or write to:

American Power Conversion
132 Fairgrounds Road
West Kingston, RI 02892
Telephone: 800-800-4APC
Website: www.apc.com

WARRANTY

We warrant that your American Power Conversion product shall be free from defects in materials manufactured by us and in our workmanship for a period of two (2) years following shipment (the "Warranty Period") for new equipment and ninety (90) days following shipment for spare parts. This limited warranty shall apply only in favor of Buyer, shall expire on the last day of such two (2) year or ninety (90) day period, whichever the case may be, and shall be subject to the following:

- (a) This warranty shall not apply to Goods which have been (i) repaired or altered by any Person other than American Power Conversion; (ii) subjected to unreasonable or improper use or use beyond rated conditions, improper storage, negligence or accident; (iii) damaged because of use of the Goods, or the incorporation of any Goods into or use of any Goods with other materials or equipment after Buyer (or any other Person using the Goods has or reasonably should have knowledge of any defect; (iv) manufactured, fabricated or assembled by any Person other than American Power Conversion (We shall assign to Buyer, to the extent same is assignable, any warranty we have received from the manufacturer of such Goods); or (v) improperly installed by any Person (including Buyer) other than APC.
- (b) This warranty shall not be effective unless we receive a written claim within thirty (30) days after discovery of any defect with respect to which a claim is made.
- (c) American Power Conversion shall have the right (but not the obligation) to verify, with its own representatives, the nature and extent of any claimed defect prior to return of the Goods to us. Upon request by American Power Conversion, Buyer shall, at its own risk and expense, promptly return the Goods in question to American Power Conversion.
- (d) The Buyer covenants to inform all subsequent buyers of the Goods of the limitation on and exclusion of warranties provided for herein. The buyer hereby indemnifies and agrees to hold American Power Conversion harmless from and against all losses, costs and expenses, including reasonable attorneys fees, incurred by American Power Conversion as a result of any third party claim relating to the purchase, sale or use of, or otherwise relating to, the Goods covered by this Agreement.
- (e) American Power Conversion's liability for any breach of the warranty shall be limited either to (i) repair or replacement (whichever we shall elect) at our Plant of any Goods determined by us to be defective, or (ii) payment of an amount equal to the invoiced cost to Buyer of the part or material which is defective, as we may elect. In no event shall American Power Conversion be required to repair, replace or reimburse Buyer for more than the part or material that is found to be defective and APC's liability shall in no event be greater than the invoiced price of the items and shall not include labor, shipping or other costs incurred in connection with the reshipment of defective Goods to us or the reinstallation of such Goods after any repair or replacement. The Goods, as a whole, shall not be construed to be a "part" or "material" for the purpose of the immediately preceding sentence. Any Goods that are repaired or replaced by us shall be redelivered to Buyer F.O.B. our Plant and shall be warranted for the remaining term of the original Warranty Period for such Goods. THE REMEDY SET FORTH IN THIS PARAGRAPH IS EXPRESSLY AND AGREED TO BE THE SOLE AND EXCLUSIVE REMEDY FOR ANY BREACH OF WARRANTY.
- (f) THE WARRANTY SET FORTH IN THIS PARAGRAPH IS IN LIEU OF ALL OTHER WARRANTIES (EXCEPT OF TITLE), EXPRESS, IMPLIED OR STATUTORY, INCLUDING WITHOUT LIMITATION ANY IMPLIED OR EXPRESS WARRANTIES OF MERCHANTABILITY, FITNESS FOR A PARTICULAR PURPOSE AND CONFORMITY TO MODELS OR SAMPLES. ALL OTHER LIABILITY, WHETHER IN CONTRACT OR TORT, STRICT LIABILITY, NEGLIGENCE OR OTHERWISE, IS HEREBY EXCLUDED.

- I. INTRODUCTION..... 1**
 - A. FEATURES 1
 - B. SPECIFICATIONS SUMMARY 4
- II. GETTING STARTED..... 5**
 - A. DISPLAY AND TOUCH POINTS 5
 - B. MODIFIABLE FIELDS 6
 - C. INITIAL CONDITIONS 7
 - D. DEFAULT SCREEN (PRESENT ENTERING CONDITIONS) 8
 - E. CHANGING TEMPERATURE SETPOINT AND RETURN TEMPERATURE ALARMS 8
 - F. CHANGING HUMIDITY SETPOINTS AND HUMIDITY ALARMS 9
 - G. STATUS DISPLAY 9
 - H. RUN HOURS 11
 - I. ALARM HISTORY 12
- III. START UP..... 13**
 - A. MANUAL CONTROL (START-UP MADE EASY!) 13
 - B. REMOTE ALARM SETUP 13
 - C. CUSTOM SETUP OF THE MICROPROCESSOR 14
 - D. RESETTING THE MICROPROCESSOR CONTROLLER 20
- IV. CONTROL OPERATIONS 22**
 - A. BLOWER 22
 - B. COOLING CYCLE 22
 - C. HUMIDIFICATION 23
 - D. CHILLED WATER/ECWS DEHUMIDIFICATION 24
 - E. HEATING CYCLE 24
- INDEX 26**
- REVISION HISTORY 28**

I. INTRODUCTION

The microprocessor based control system is the nerve center of the environmental control unit. The microprocessor control system has been designed with the needs of the engineer, operator, owner and installation in mind. It encompasses a wide array of innovative features designed to make it easy to operate and reliable to the user.

Although it ultimately controls temperature and humidity, the microprocessor monitors and controls many internal and external functions. Some of the parameters controlled or monitored are temperature and humidity setpoints, multiple stages of reheat, cooling and humidification, input power, delays, run time history and alarm status.

The display shows the actual temperature and humidity and all current active functions such as heat, cool, dehumidification and humidification, setpoints, alarms, and parameter modifications using a series of easily accessed menus. The controller retains configuration information in a nonvolatile memory, which can be accessed and changed by using a password.

A. Features

Easy to Read Display

The control system is microprocessor-based with a four line by 20 character back-lit LCD alphanumeric display. The panel displays all controller functions and alarms as well as operator instructions.

Field Programmable

The microprocessor can be field programmed for all configuration selections; the user can match the unique needs of conditioned space simply by following the prompts built into the controller.

Operator Instructions

The microprocessor uses text for display - no look up tables or additional equipment are needed.

Run Times

The microprocessor keeps track of the actual running hours of all the motor devices and operational cool times. These hours are displayed on demand. The microprocessor can also notify the operator that maintenance is due at preset times if desired. This feature can help keep the control equipment in peak condition to minimize down time.

Security

The flexibility, reliability and control offered by the microprocessor is extensive. However, these benefits need to be reserved for operators that understand their proper use. The microprocessor provides two levels of restricted entry into the configuration options to ensure that operating parameters are not changed by unauthorized personnel.

Nonvolatile Memory

The microprocessor is equipped with a nonvolatile memory that retains the current configuration and alarm status in the event of a power loss.

Alarm Control

The controller can have up to twelve (12) external inputs/alarms, which are defined by internal programming. In addition to these 12 digital inputs, internal alarms are provided for high and low return air temperature and humidity, loss of power and low voltage as well as up to four additional analog sensors as needed.

Upon receipt of any alarm, the alarm condition is displayed along with suggested operator actions to be taken. An audible alarm is also generated.

Custom alarm messages may be programmed. Consult the factory on your special alarm needs.

Setpoints

Adjustable setpoints for temperature, humidity, temperature band, humidity band, high temperature alarm, low temperature alarm, high humidity alarm and low humidity alarm are made through configuration options. The alarm setpoints are adjustable as a function of the band selected and vary as the setpoint is varied. The controller automatically computes the reasonable alarm setpoint ranges based on the actual setpoint and band.

Cooling Inhibit

All cool functions are automatically inhibited in the event that the temperature drops 4° below the heating setpoint and dehumidification is called for. Cooling functions are automatically restored when the temperature returns to the heating setpoint. During inhibit, the controller displays "COOL INH".

Short Cycle Protection

The controller prevents any compressor from re-starting in less than a user modifiable delay after its last operation.

Small Room Operation

If selected, this feature inserts a time delay between heat and cool cycles to prevent excessive cycling. The time delay is adjustable.

Compressor Sequencing

In two compressor units, if two compressors are selected and more than one compressor is present, the compressor with the least amount of run time is the one selected when cooling is called for. After the lead compressor has run a modifiable number of hours, the second compressor becomes the lead compressor for the next time period. When the second compressor has run the configured number of hours, the first compressor becomes the lead compressor.

Metric International System of Units (SI) or British Inch-Pound (IP) Compatible

The controller may be configured to display all temperature readings in degrees Fahrenheit or Celsius.

Common Alarm Output

The controller has available at the field wiring connector a dry contact that will activate if an alarm was programmed to activate it. The contact closes upon the receipt of the alarm and opens when the alarm has been acknowledged.

Inter-stage Delay

The inter-stage delay between stages of heat and stages of cool is field adjustable.

Hydronic Sensors

The controller can monitor and use temperature sensors on optional chilled water and hot water supplies in determining if it is sensible to use chilled water for cooling or hot water for heating. It also provides for high and low alarm functions on these inputs.

B. Specifications Summary

Note: Values do not reflect the capability of the equipment to achieve the control values, only what the controller itself can perform. The values listed below are designed to cover standard as well as equipment designed for special applications. Consult the factory or your representative for specific control range values for the actual equipment.

Control Temperature Range:	68°F to 95°F or 20°C to 35°C
Control Temperature Resolution:	0.1°F
Control Temperature Tolerance:	1°F
Control Temperature Inputs:	NTC, 10K
Control Humidity Range:	30.0% to 70.0% RH
Control Humidity Resolution:	0.1%
Control Humidity Tolerance:	3%
Control Humidity Input:	0-1 volt or 4-20ma
Number of Compressor Stages:	2 maximum
Number of Heater Stages:	3 maximum
Proportional Cool Valve Output:	0-10 Volts
Operating Temperature Range:	0°C to 50°C
Input Power:	24 VAC, 3V@30VA

II. GETTING STARTED

A. Display and Touch Points

The microprocessor displays messages on the 4 line by 20 character alphanumeric display on the front of the panel (see figure 1). The display is used to show the operating conditions of the environmental control unit, any alarms that may be present and prompts the operator through all steps required to configure the system. There is a cursor in the form of an underline “_” indicating the field currently selected. If the cursor is in the upper left hand corner of the display, no field is selected. The microprocessor has a total of 15 touchpoint controls. There are five “buttons” located in a cluster in the lower right hand corner. Ten other “touchkeys” are located above and to the right of the buttons. For the purposes of this manual the “touchkeys” will be referred to only as “keys”. An illuminated green LED in the center of the “on/off” button indicates the unit is in the run mode. The fan may or may not be running depending on internal timers. An illuminated red LED in the center of the “alarm” button indicates an alarm condition exists.

Button Cluster – see figure x for the location of this group.

- ✎ **On/Off** button is pressed to start the unit locally when it is in the UNIT STOPPED mode. The same button is also pressed to stop the unit locally when it is in the UNIT RUN mode.
- ✎ **Alarm** button is pressed to immediately display the first alarm.
- ✎ **Up Arrow** button is pressed to turn to the next higher page within a menu. It is also used for increasing values for control parameters. Parameters can be increased in small increments by pressing the button once. To increase in large increments, scroll up by holding the button in. To stop scrolling, just release the button.
- ✎ **Down Arrow** button is pressed to turn back a page within a menu. It is also used for decreasing values for control parameters. Parameters can be decreased in small increments by pressing the button once. To decrease in large increments, scroll down by holding the button in. To stop scrolling, just release the button.
- ✎ **Enter** button is pressed to accept parameters. **Important:** before a parameter becomes permanent you must press the “enter” key until the cursor is in the upper left hand corner. The “enter” button is also used to move the cursor inside of a menu. By doing this you can access different “pages”. The “enter” button is also used to clear an alarm after it displays.

Status Cluster – see figure x for the location of this group

- ✎ **Run Hours** key is pressed to access run hours information including: accumulated run hours on components, run hour intervals, and hours left before next run hour alarm.

 **Status** key is pressed by the user to show incoming air conditions and component status of the environmental control unit.

 **Alarm History** key is pressed to access past (cue/number) alarms.

Setpoints Cluster – see figure x for the location of this cluster.

 **Temp** key is pressed to gain direct access to the Cooling and Reheating setpoints

 **Humid** key is pressed to gain direct access to the Humidification and Dehumidification setpoints.

 **Special** key is pressed to gain direct access to the clock feature for setting the time and date.

 **Config** key is pressed to access the Technician menus for custom setup of the controller. The menu allows further access to the following pages:

- ?? Manual Control
- ?? Remote Alarm Setup
- ?? Factory Setup
- ?? Input/Output Setup
- ?? Cooling Setup
- ?? Heating Setup
- ?? Humidity Setup

Help Key

 **Help** key is pressed to provide more information about specific problems.

Network Key

 **Network** key is pressed to program the network for redundant group

B. Modifiable Fields

Toggling Fields

If a field is not a numeric value, it can be toggled to the desired selection by moving the cursor under the field and pushing the *“Up”* or *“Down”* button.

Numeric Fields

Numeric fields can be modified by moving the cursor under the field and pushing the *“Up”* or *“Down”* button to increase or decrease the value. The fields will change value faster by holding in the button. Releasing the button will stop the scrolling.

C. Initial Conditions

Power Up Screen

At initial power up, the display will momentarily show the unit type and date of the program. The unit types will be factory set to match your specific unit and will be one of the following: DX, CW, AFX, CM-DX, CM-CW, TC-DX, or TC-CW.

American Power Conversion
DX
Software Ver:012199

Handling Alarms

After a power up, the microprocessor's "alarm" button LED should be indicating an alarm is present. If no action has been taken thus far the display will be rotating through the following screens.

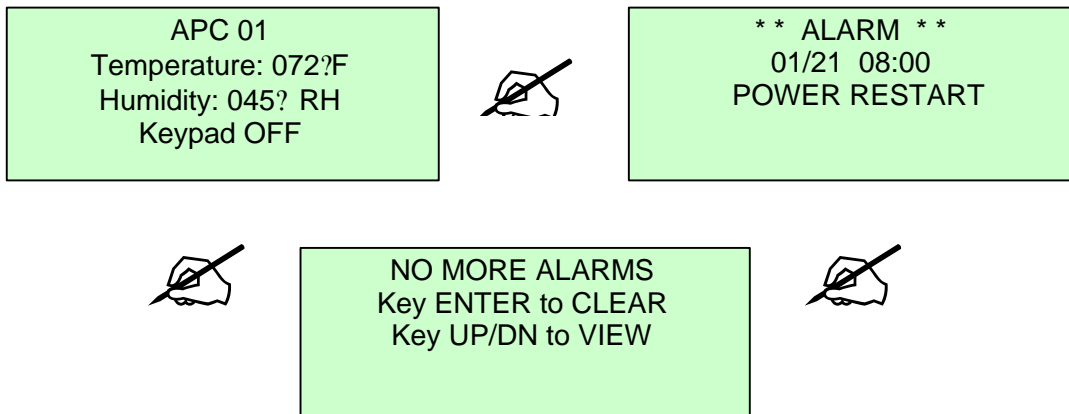

Display the alarms by pressing the "alarm" button. You will be prompted to take desired action by the screen directly above. After exiting the alarm screen the "Default Screen" (upper left) will return and display the present entering air conditions. The first line of the default screen is user-defined text and can be easily changed to personalize your unit's name with up to ten digits. Changing the user defined text is covered in the remote alarm setup section.

D. Default Screen (Present Entering Conditions)

Key inactivity for 60 seconds will cause the display to return to the Default Screen which always shows the entering air conditions of the environmental control unit.

E. Changing Temperature Setpoint and Return Temperature Alarms

Temperature Setpoint

To change the temperature setpoint, locate the “*SETPOINTS*” key cluster on the display. Press the “*Temp*” key. The display below will appear. Find the button cluster on the display and press the “*enter*” button once. This will move the cursor to the Cool Setpoint and then to the Heat Setpoint if you press the “*enter*” button again. Once the cursor is below the setpoint you wish to change, press the “*Up*” or “*Down*” button to raise or lower the

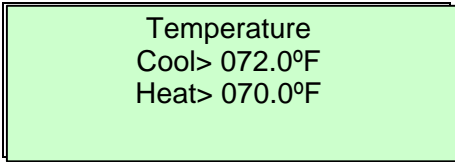

```

Temperature
Cool> 072.0°F
Heat> 070.0°F
  
```

setpoint to the desired value. Holding the buttons continuously will scroll the setpoints faster. Once the desired changes have been made press the “*enter*” button again and the cursor will return to the upper left hand corner of the display. **Only by moving the cursor back to the upper left corner will the controller accept this new value.** Your next button of choice may then be pressed.

High and Low Return Temperature Alarms

To change the return temperature alarms, locate the “*SETPOINTS*” key cluster again on the display. Press the “*Temp*” key. The temperature setpoint screen as shown above will appear. Press the “*down*” arrow button once to move to the next screen which will display as shown below. Find the button cluster on the display and press the “*enter*”

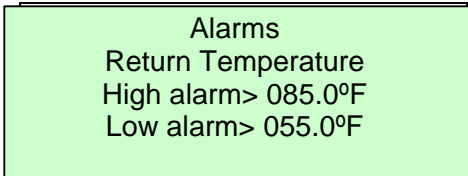

```

Alarms
Return Temperature
High alarm> 085.0°F
Low alarm> 055.0°F
  
```

button once. This will move the cursor under the High temperature alarm setpoint. Pressing the “*enter*” button again will move the cursor under the Low temperature alarm setpoint. Once the cursor is below the setpoint you wish to change, press the “*Up*” or “*Down*” button to raise or lower the setpoint to the desired value. Holding the buttons continuously will scroll the setpoints faster. Once the desired changes have been made press the “*enter*” button again and the cursor will return to the upper left corner of the display. **Only by moving the cursor back to the upper left corner will the controller accept this new value.** Your next button of choice may then be pressed.

F. Changing Humidity Setpoints and Humidity Alarms

Humidity Setpoint

To change the Humidity setpoint, locate the “*SETPOINTS*” key cluster on the display. Press the “*Humid*” key. The display below will appear. Find the button cluster on the

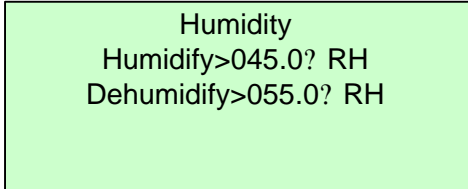

Humidity
Humidify>045.0? RH
Dehumidify>055.0? RH

display and press the “*enter*” button once. This will move the cursor under the High humidity alarm setpoint. Pressing the “*enter*” button again will move the cursor under the Low humidity alarm setpoint. Once the cursor is below the setpoint you wish to change, press

the “*Up*” or “*Down*” button to raise or lower the setpoint to the desired value. Holding the buttons continuously will scroll the setpoints faster. Once the desired changes have been made press the “*enter*” button again and the cursor will return to the upper left corner of the display. **Only by moving the cursor back to the upper left corner will the controller accept this new value.** Your next button of choice may then be pressed.

Humidity High and Low Alarms

To change the return humidity alarms, locate the “*SETPOINTS*” key cluster again on the display. Press the “*Temp*” key. The humidity setpoint screen as shown above will appear. Press the “*down*” arrow button once to move to the next screen, which will

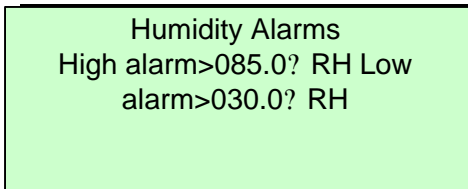

Humidity Alarms
High alarm>085.0? RH Low
alarm>030.0? RH

display as shown. Find the button cluster on the display and press the “*enter*” button once. This will move the cursor under the High humidity alarm setpoint. Pressing the “*enter*” button again will move the cursor under the Low humidity alarm setpoint. Once the cursor is

below the setpoint you wish to change, press the “*Up*” or “*Down*” button to raise or lower the setpoint to the desired value. Holding the buttons continuously will scroll the setpoints faster. Once the desired changes have been made press the “*enter*” button again and the cursor will return to the upper left corner of the display. **Only by moving the cursor back to the upper left corner will the controller accept this new value.** Your next button of choice may then be pressed.

G. Status Display

Complete information about system status is easily attained from the Microprocessor. The following screens do not require any password. Since these screens are display only, no changes can be made to the program from these screens.

Return Air Conditions

Find the status cluster on the display and press the "status" key. The display at left will appear. This screen will also appear after 60 seconds of no key activity (rest screen). The top line has 10 digits of user defined characters for unit identification that can be programmed in configuration mode. Return temperature and humidity are displayed as shown. The bottom line, as shown, shows the system is off. If the system is in the ON mode, the bottom line will display "Fan ON" after first showing "Initial delay...".. If the unit is in Dehumidification mode, the bottom line will also display "Dehumidify".

```

APC 01
Temperature: 072°F
Humidity: 050%RH
Keypad OFF
    
```

Optional Sensors Status

If the unit has either the "PC" (Pre-Cool) or the "ECWS" (External Chilled Water Supply) option, the display will show the second screen as shown in this paragraph. For "PC" and "ECWS" units the display will at minimum display the top line which show the incoming temperature of the cooling medium. If unit was ordered with "Chilled Water Return Sensor Option", the second line will appear on this screen which shows the leaving temperature of the cooling medium. If the unit was ordered with proportional hot water reheat, this screen will also display the third line which shows the incoming temperature of the hot water source. **If the unit does not have the "PC" or "ECWS" than the display will not have this "second" screen at all.**

```

Opt Sensors
CW Supply T 045°F
CW Return T 055°F
HW Temp 180°F
    
```

Component Status

From the "rest screen" or after pressing "status" key, press the "down arrow" button. Depending on the type of unit, and what options were selected, the appearance of the third status screen can take many forms. A few examples are shown in this paragraph. This single screen gives detailed information about the status of each component within the environmental control unit. If the system

DX

```

Keypad: OFF
Cool: C1-OFF, C2-OFF
Heat:0
Hum: OFF
    
```

is off, the top line displays as shown. If unit is running, the top line will display "Fan ON". For Air-cooled, Water-cooled, or Glycol-cooled DX units the second line displays the status of each compressor as shown in the DX example. If Compressor 1 is

CW

```

Lag Unit: OFF
Cool: 000?
Heat: 0
Hum: OFF
    
```

running, the display will show "C1-ON". If C1 is pumping down the display will show "C1-PMDN". If the unit has semi-hermetic compressors and unloaders, the display will show "C1

FULL” if unloaders are off (loaded), and “C1-UNLD” if unloaders are on (unloaded). The same would be true for Compressor 2. If the unit has only one stage of cooling, only C1 status will display as shown in DX w/ECWS example. If your unit is a chilled water unit, the percent open value of the valve will display as shown in the CW example. If the unit

**DX w/
ECWS**

```

Remote: OFF
Cool: C1-OFF
ECWS: 000?
Heat: 000?
    
```

has ECWS or PC option, the third line will display “ECWS” or “PC”, the % open status of the water valve, as shown in the DX w/ECWS example. If the unit does not have the ECWS or PC option, the third line will be blank as shown in CW and DX example. For standard reheat

the fourth line will display, on the left side as shown in the DX example, the number of heat stages that are on. If the heat is programmed for proportional reheat, as shown in the DX w/ECWS example, the percent open value of the valve will be displayed instead. The right side of line four displays if the humidifier is “ON” or “OFF” for standard humidification as shown in the DX & CW examples. If the unit is programmed with proportional humidification option, the display will show the output % of the humidifier as shown in the DX w/ECWS example.

H. Run Hours

The run hours of all digital outputs from one to ten can be viewed easily in the Microprocessor. Locate the “*status cluster*” on the display. Press the “*Run Hours*” key. The following display will appear. The respective digital output from the microprocessor

```

Run Hours: D01
Blower: 00000hr
Alarm set: 0000hr
Next alarm: 0000hr
    
```

board is displayed in the upper right hand corner (DO_). The second line names the output and provides the actual number of hours the output has been on. The third line “Alarm set>” displays the interval at which the alarm will occur. The last

line “Next alarm:” displays the amount of time left before the next alarm occurs. Pressing the “*down arrow*” button will display the next run time alarm and it’s respective settings. After scrolling through the last run time alarm, the first will appear again to continue the viewing loop.

I. Alarm History

Viewing Alarm History

The Microprocessor will track the last 20 alarm occurrences. Each occurrence is displayed as a list. Each list will store up to ten different alarms per time occurrence.

ALARM HISTORY
Key ENTER to view

To access the alarm history, locate the status cluster in the display. Press the "Alarm History" key. The display will appear as shown at immediate left. Pressing the "enter" button on the button cluster will display the most recent occurrence or "list" as shown in the next screen.

The first line indicates the date, time and the sequential list number or "list". In this case the date would be January 1, the time would be 1:15 in the afternoon (time is based on a modified military format), and this would be the third alarm occurrence in sequence (L:03) or "list 3". With a new unit right out of the box, the oldest occurrence stored would be "L:01". As more alarms occur, the pages will increase in number. Each occurrence will remain on the same "list number". After a sequence of 20 different alarm lists have transpired, the next alarm overwrites the first alarm in the loop. Then the oldest alarm will be in front of the most recent alarm in the loop. The second line will indicate the return temperature and humidity level at which the alarm(s) occurred. The third line will indicate the first alarm on this list. The fourth line will show the total number of alarms that transpired during this time sequence or "list" and prompt you to press the "enter" button to view the rest. To view the next time occurrence or "list" in sequence press the "down arrow" button. To view the previous time occurrence or "list", press the "up arrow" button. If there is more than one alarm on a list, follow the prompt and press the "enter" button. The screen will display the rest of the alarms that transpired during that time sequence. In this case the two alarms that most recently occurred are a High Temperature Alarm and a High Humidity Alarm.

01/01 13:15 L:03
T: 072.0°F
H: 045.0?
Hi Temp alarm
2 alarms: ENTER to view

The second line will indicate the return temperature and humidity level at which the alarm(s) occurred. The third line will indicate the first alarm on this list. The fourth line will show the total number of alarms that transpired during this time sequence or "list" and prompt you to press the "enter" button to view the rest. To view the next time occurrence or "list" in sequence press the "down arrow" button. To view the previous time occurrence or "list", press the "up arrow" button. If there is more than one alarm on a list, follow the prompt and press the "enter" button. The screen will display the rest of the alarms that transpired during that time sequence. In this case the two alarms that most recently occurred are a High Temperature Alarm and a High Humidity Alarm.

Hi Humidity Alarm

The screen will display the rest of the alarms that transpired during that time sequence. In this case the two alarms that most recently occurred are a High Temperature Alarm and a High Humidity Alarm.

Clearing Alarm History

Caution: Once the history is cleared from memory, it is permanently lost and cannot be recalled. In some instances it may become desirable to clear the history from the controller. Some instances listed here may be desirable but are not limited to: Changing or updating the program, equipment overhaul, etc. Press the "alarm history" key and the ALARM HISTORY screen will appear. Press the blank key and the cursor will move above the word "Key" on the display. Press the "help" key and the history will reset. After the initial display appears, the history has been reset.

III. START UP

It is essential that the user document any changes from the default setup on the setup checklist that is located in the back of this manual. The changes that the user makes to the setup are stored in non-volatile memory and are not affected by power outages.

A. Remote Alarm Setup

For the convenience of the user, all remote alarm settings are located in one readily accessible menu. To access the Remote alarm setup, press the *“config”* key on the “setpoints” cluster. The Technician Menu will appear. Press the *“enter”* button to move the cursor to the “Remote alarm setup>” as shown by the highlight. At this point press the *“down arrow”* button to bring up the first page in remote alarm setup. All pages will be labeled as “Alarms”,

Alarms	COM XFR
EEPROM Fail	>ON OFF
Airflow	>ON OFF
Ret Hi Temp	>ON OFF

scroll to the page that has the alarm name of choice by pressing the *“down arrow”* or *“up arrow”* key. Notice as the screens scroll down the page number changes. From the factory all alarms will be defaulted with “COM” selected “ON” and “XFR” selected “OFF”. All seven pages allow the user to customize the alarm logic. For each alarm the user has a choice of the following:

“COM” Setting (Common Option)

- ?? If the alarm name has its appropriate “COM” selected “ON”, whenever that alarm occurs the unit will display the alarm locally (at the unit) and close the Common Alarm Dry Contacts (see unit wiring)
- ?? If the alarm name has its appropriate “COM” selected “OFF”, whenever that alarm occurs the unit will still display the alarm locally but the Common Alarm Contacts will not close.

“XFR” Setting (Transfer Option)

- ?? If the alarm name has its appropriate “XFR” selected “ON”, whenever that alarm occurs the unit will display the alarm locally and shut down and transfer operations to another standby unit in the same Redundant Unit Group Network. If the unit is a standalone unit, in this case the unit will still shut off, and there simply will not be any other units to transfer to.
- ?? If the alarm name has its appropriate “XFR” selected “OFF”, whenever that alarm occurs the unit will display the alarm locally, keep running but will not transfer operations to another standby unit in the network or not.

With the display in the first page, note the alarms listed. The alarm named “EEPROM Fail” occurs whenever the control board fails. In this display, since “EEPROM Fail” has it’s “COM” selected “ON” and it’s “XFR” selected “OFF”, when the control board fails this unit will display the “EEPROM Fail” alarm locally,

Alarms	COM	XFR
EEPROM Fail	>ON	OFF
Airflow	>ON	OFF
Ret Hi Temp	>OFF	OFF

close the common alarm contacts, and attempt to continue to run. Since “Airflow” has it’s “COM” selected “ON” and it’s “XFR” selected “ON”, when the “Airflow” alarm occurs the unit will alarm locally, close the common contacts, shut

down and pass demand to a standby unit. Since “Ret Hi Temp” has it’s “COM” selected “OFF” and it’s “XFR” selected “OFF”, when a high return temperature alarm occurs, the unit will alarm locally and attempt to continue to run. All of the remote alarms available are listed below:

- ?? EEPROM Fail
- ?? Airflow
- ?? Ret Hi Temp
- ?? Ret Low Temp
- ?? Hi Temp
- ?? Low Temp
- ?? Low Temp
- ?? High Hum
- ?? Low Hum
- ?? C1 High PSI
- ?? C2 Low PSI
- ?? C2 High PSI
- ?? Water Detect
- ?? Humidifier
- ?? Smoke Detector
- ?? Filter
- ?? Hi Temp
- ?? C1 LP
- ?? Water Flow

B. Custom Setup of the Microprocessor

```

Technician Menu
Remote alarm setup >
Custom setup..... >
    
```

Setup of the controller depends on the options included with the environmental control unit as well as specific applications. The microprocessor allows a wide variety of parameters to cover most applications and will exceed the capability of other controllers. It

becomes the responsibility of the user to set values in the controller that do not exceed the limits of the environmental control unit. To access the setup pages, press the “config” key. The technician menu will appear. Press the “enter” button until the cursor scrolls down to “Custom setup...”. Press the “down arrow” button and page 1 will appear.

System Setup: Page 1

The system setup page allows the user to access the system delays. The “fan delay” is factory set with no delay, and is user adjustable from 0-999 seconds. When the environmental control unit is in the “keypad OFF” mode, in standby, or in remote stop, this setting delays the amount of time before the blower runs after the “on/off” button is

System Setup	pg.1
Fan delay	>000s
Mode delay	>011s
Alarm Buzzer	>OFF

pressed, the unit is called for in redundant mode, or remotely started. The “Mode delay” is factory set at 11 seconds. This setting delays the first mode of operation after the blower starts. It is user adjustable from 1 –

999 seconds. These two delays allow a wide range of settings to stagger the start-up of multiple units to prevent power overloads or allow external dampers to drive open. The “Alarm Buzzer” is factory set to “OFF”. When off, the alarm will not sound during an alarm condition, but will still sound momentarily during power up. When set to “OFF”, the alarm will sound whenever any alarm condition exists. With the cursor in the upper left hand corner, press the “enter” button. The cursor will move to each setting as desired. Pressing the “Up” or “Down” arrow button will increase or decrease the chosen setting as desired.

Passwords: Page 2

Passwords	Pg.2
Level 1	>0000 Setpts
Level 2	>0000 Config

There are two password levels available for the user of the environmental control unit on page 2 of the custom setup. All passwords are factory set at all zeros. As long as these passwords are not changed, there will be no

prompts to gain access to any levels. If the user enters a password for Level 1, access to the temperature and humidity setpoints will be restricted by the “passwords” screen. The password will not become effective for level I until a password is entered by the user for Level II. The Level II password restricts access to the setup menus. The Level II password will allow access to both setpoints and setup menus. The controller waits for 1 minute of no key activity before the setpoints take affect. When gaining access with a password the door is allowed to stay open for 1 minute without reentering the password. This feature prevents the user from having to re-enter the password while traveling inside the controller. To enter a password press the “Config” key and the “Technician Menu” will appear. Press the “enter” button until the cursor is next to “Custom setup...”. Press the “down arrow” button to access the custom setup. Press the “down arrow” button again to move to “Passwords” screen on page 2. Press the “enter” button until the cursor is below the Level I or Level 2 password as desired. Press the “up arrow” or “down arrow” button to change the password to the desired setting. Continuously pressing the keys will scroll faster. To stop scrolling, release the key. Single strokes will change the setting slowly. **Call Technical Support (888-695-6500) if access by user is denied because of a forgotten password.**

Temperature Units: Page 3

The microprocessor can be easily programmed to display and control functions in either Fahrenheit or Centigrade. To change the display press the "Config" key and the "Technician Menu" will appear. Press the "enter" button until the cursor is next to

Temperature	Pg.3
Units	>Fahrenheit
Change set points to	Fahrenheit

"Custom setup...". Press the "down arrow" button to access the custom setup. Press the "down arrow" button again to move to "Temperature" screen on page 3. Press the "enter" button to move the cursor under the temperature unit of measure as shown by the

highlight. Press the "up arrow" or "down arrow" to set the program to Fahrenheit or Centigrade. Press the "enter" button again to move the cursor to the upper left corner of the display. Press the next button of choice.

Communications: Page 4

This page allows the setup of the address of the device when the supervisor network is installed. The address must be from 1 to 200 to be a valid device on the supervisor network. Each device on the segment must have a unique number. Two devices with

Communications	pg.4
Unit Name	>APC 01
ID Number	>000
Baud Rate	>1200

the same address will cause the network to malfunction. This page also allows the user to input up to 10 characters of user defined code for unit identification on the display. To access this page press the "Config" key and the

"Technician Menu" will appear. Press the "enter" button until the cursor is next to "Custom setup...". Press the "down arrow" button to access the custom setup. Press the "down arrow" button again to move to "Temperature" screen on page 4. Press the "enter" button to move the cursor under the specific digit in the "Unit Name", "ID Number", or "Baud Rate" as desired. Press the "up arrow" or "down arrow" to change each selection to the desired setting. The Baud Rate can be selected from 1200 to 19200.

Temperature Control: Page 5

Control	pg.5
Bands	
Type Int	>HT CL
Temp	>P 600s 02 02F

This screen allows the user to access the temperature control type and the return temperature dead-bands. The two control types are "P" (proportional) and "P+I" (proportional and integral). The controller is

factory set for "P" type control, but can be programmed for "P+I" if the controller does not seem to be responding fast enough. Set for "P" type control, the microprocessor operates within the band around the setpoint. The strength of the demand signal ranges proportionately from 0-100% from the setpoint to the end of the band. Set for "P+I" type control the microprocessor operates the same as "P" type except after the integral timer has elapsed if the return temperature has not reached the setpoint the signal increases by 100%. The integral timer is factory set for 600 seconds but is field adjustable for 1-999 seconds. The dead-bands for reheating and cooling are factory set at 2°F (1°C), but are field adjustable from 1-99°F/C. These factory settings have been determined as the

best possible for most environmental control applications and should not be changed unless absolutely necessary. Call the Technical Support Division for guidance (888-695-6500). To access this screen press the “Config” key and the “Technician Menu” will appear. Press the “enter” button until the cursor is next to “Custom setup...”. Press the “down arrow” button to access the custom setup. Press the “down arrow” button again to move to “Control” screen on page 5. Press the “enter” button to move the cursor under the “Type”, “Int”, “HT” or “CL” dead-band as shown by the highlight. Press the “up arrow” or “down arrow” to set choice of control, integral, or dead-band as desired. Press the “enter” button again to move the cursor to the upper left corner of the display. Press the next button of choice.

Humidity Control: Page 6

This screen allows the user to access the humidity control type and the humidity dead-bands. The two control types are “P” (proportional) and “P+I” (proportional and integral). The controller is factory set for “P” type control, but can be programmed for “P+I” if the controller does not seem to be responding fast enough. Set for “P” type control, the microprocessor operates within the band around the setpoint. The strength of the demand signal ranges proportionately from 0-100% from the setpoint to the end of the band. Set for “P+I” type control the microprocessor operates the same as “P” type except after the integral timer has elapsed if the return humidity has not reached the setpoint the signal increases by 100%. The integral timer is factory set for 600 seconds but is field adjustable for 1-999 seconds. The dead-bands for humidification and

Control	pg.6
Bands	
Type Int	>HU DH
Hum	>P 600s 05 05%

dehumidification are factory set at 5%RH, but are field adjustable from 1-99 %RH. These factory settings have been determined as the best possible for most environmental control applications and should not be changed unless absolutely

necessary. Call the Technical Support Division for guidance (888-695-6500). To access this screen press the “Config” key and the “Technician Menu” will appear. Press the “enter” button until the cursor is next to “Custom setup...”. Press the “down arrow” button to access the custom setup. Press the “down arrow” button again to move to “Control” screen on page 6. Press the “enter” button to move the cursor under the “Type”, “Int”, “HU” or “DH” dead-band as shown by the highlight. Press the “up arrow” or “down arrow” to set choice of control, integral, or dead-band as desired. Press the “enter” button again to move the cursor to the upper left corner of the display. Press the next button of choice.

Compressor Setup: Page 7

The compressor control screen allows the user to access the “Small Room Delay”, control the compressor rotation and rotation time. The microprocessor has a Inter-Mode Delay of 300 seconds. The “Small Room Delay” is factory set at 0 seconds and is field adjustable from 0-999 seconds. The additional time entered for the Small room delay will be added to the Inter-Mode Delay to help prevent rapid cycling between heating and cooling modes. Additional time helps allow the room to stabilize between modes. **This feature does not preclude the fact that the environmental control unit must be sized to the load.** With “Rotation” selected “ON”, the microprocessor allows the LEAD Compressor to become the LAG compressor. Rotation is factory set to be “ON”, but can

Compressors	pg.7
Small room delay	>000s
Rotation	>ON
Rotation time	>010h

be selected “ON” or “OFF”. The “Rotation time” is the amount of run time in hours the LEAD compressor must run before becoming LAG. Rotation time is factory set at 10 hours, but is field adjustable from 1 – 999 hours. To access this screen press the “Config” key and

the “Technician Menu” will appear. Press the “enter” button until the cursor is next to “Custom setup...”. Press the “down arrow” button to access the custom setup. Press the “down arrow” button again to move to “Control” screen on page 7. Press the “enter” button to move the cursor under the “Small room delay”, “Rotation”, or “Rotation time” as shown by the highlight. Press the “up arrow” or “down arrow” to set choice of delay, rotation, or time as desired. Press the “enter” button again to move the cursor to the upper left corner of the display. Press the next button of choice.

Temperature Sensor Offset (Calibration of AI1): Page 10

This screen allows the user to calibrate the temperature portion of the Temperature & Humidity sensor from the display without making adjustments to the sensors in the environmental control unit. The offset is factory programmed for 0.0°F, but is field adjustable for –10.0°F to +10.0°F. Any offset beyond this range requires replacement of the Temperature & Humidity Sensor. If the return temperature has been determined to

Sensor Offset	pg.10
A1. RETURN TEMP	
CALABRATION	>00.0°F
ACTUAL	>072.0°F

be too high, a negative offset would need to be programmed. If the return temperature has been determined to be too low, a positive offset would need to be programmed. APC recommends that an industrial quality

calibrated instrument be used to determine if an offset is required. Ensure the instrument is sampling the same air the unit’s sensor is sampling, by locating the instrument’s bulb as close to the unit’s sensor as possible. To access this screen press the “Config” key and the “Technician Menu” will appear. Press the “enter” button until the cursor is next to “Custom setup...”. Press the “down arrow” button to access the custom setup. Press the “down arrow” button again to move to “Sensor Offset” screen on page 10. The second line shows the number of the analog input on the controller, which in this case is “A1” or actually “AI1”. The third line is the programmable offset. The fourth line shows the displayed output in 1/10°F increments. However the status screen will only show whole number values by dropping the 1/10°F digit. Press the “enter” button to move the cursor to the “Calibration>_00.0°F” as shown by the highlight. Press the “up arrow” button to increase in the positive direction or “down arrow” button

to decrease in the negative direction the setting as desired. Press the “enter” button again to move the cursor to the upper left corner of the display. The actual reading on the fourth line should change to the desired output. If satisfied, press the next button of choice.

Sensor Offsets for AI2 – AI4: Pages 11-13

These screens will not show in the custom setup unless they are factory configured, which depends on the options that are included in the environmental control unit. Offsets are handled the same way as temperature and humidity sensor offsets.

Humidity Sensor Offset (Calibration of AI5): Page 14

This screen allows the user to calibrate the humidity portion of the Temperature & Humidity sensor from the display without making adjustments to the sensors in the environmental control unit. The offset is factory programmed for 0.0%RH, but is field adjustable for -10.0%RH to +10.0%RH. Any offset beyond this range requires replacement of the Temperature & Humidity Sensor. If the return humidity has been determined to be too high, a negative offset would need to be programmed. If the return

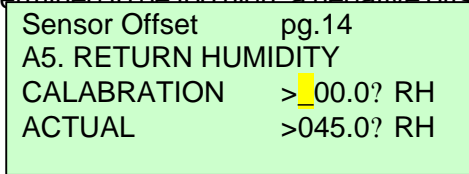

humidity has been determined to be too low, a positive offset would need to be programmed. APC recommends that an industrial quality calibrated instrument be used to determine if an offset is required.

Ensure the instrument is sampling the same air the unit’s sensor is sampling, by locating the instrument’s bulb as close to the unit’s sensor as possible. To access this screen press the “Config” key and the “Technician Menu” will appear. Press the “enter” button until the cursor is next to “Custom setup...”. Press the “down arrow” button to access the custom setup. Press the “down arrow” button again to move to “Sensor Offset” screen on page 14. The second line shows the number of the analog input on the controller, which in this case is “A5” or actually “AI5”. The third line is the programmable offset. The fourth line shows the displayed output in 1/10%RH increments. However the status screen will only show whole number values by dropping the 1/10%RH digit. Press the “enter” button to move the cursor to the “Calibration>_00.0? RH” as shown by the highlight. Press the “up arrow” button to increase in the positive direction or “down arrow” button to decrease in the negative direction the setting as desired. Press the “enter” button again to move the cursor to the upper left corner of the display. The actual reading on the fourth line should change to the desired output. If satisfied, press the next button of choice.

Analog Output Setup (AO1): Page 17

This screen allows access to the setup of the analog output 2 to change the action, the starting voltage and the span. If the environmental control unit does not have any options that use this output, the name of the output will appear as shown "NA". If this output is required for the unit, it will be factory configured for one of the following: ECWS, CG Damper, Humidifier, PC, COOL, or HEAT. If the unit is configured for one of these options, the name will appear in this screen instead of "NA" on line 2. Line four

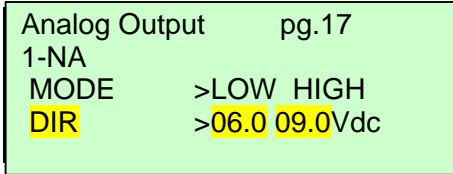

allows the option to switch from direct acting to reverse acting and define the signal. To access this screen press the "Config" key and the "Technician Menu" will appear. Press the "enter" button until the cursor is next to "Custom setup...". Press the "down arrow"

button to access the custom setup. Press the "down arrow" button again to move to "Analog Output" screen on page 17. Press the "enter" button to move the cursor to the "MODE" selection, "LOW" or "HIGH" field as desired and shown by the highlight. Press the "up arrow" or "down arrow" to change the mode from "DIR" to "REV" or change the voltages as desired. The starting voltage is factory set for 6.0 VDC and the Ending Voltage is set for 9.0VDC. The span in this case would be 3.0VDC. These values are field adjustable from 0.0 – 10.0VDC if necessary. Press the "enter" button again to move the cursor to the upper left corner of the display. Press the next button of choice.

Analog Output Setup (AO2): Page 18

Analog output number two setup is similar to setup of AO1.

D. Resetting the Microprocessor Controller

The controller stores setup information in a non-volatile memory. This setup information contains all of the adjustable parameters such as temperature setpoints. The setup also depends on the options that were ordered with the environmental control unit. The program has a default set of values for the setup memory used when a unit is initially started, or software is changed. **Before performing setup it is recommended the user refer to changes from default settings that should be documented in the back of this book in the setup checklist.**

1
 APC
 Not selected
 Software Ver: 020599

Resetting can be done at two different instances. The first is at the moment of power-up. The second can be done any time by pressing the "blank" key. In either instance the Software Version screen will appear with the cursor in the

upper left corner. Press the "enter" button to bring the cursor directly above the "S" as

2
 WAIT-RESETTING
 Not selected
 Software Ver: 020599

shown by the highlight in display #1 at left. Simultaneously press the "Temp" key and the "Run Hours" key and the cursor should move under the date as shown by: "Software Ver: 020599". The

date that appears on the bottom line will correspond to the particular program. At this

3
 Configuration
 Units >Fahrenheit
 Model >Not Selected

point, press the "up" or "down" arrow button to change the date. After any change to the date has been made, press the "enter" button. The display will then show display #2. After a brief moment display #3 will appear. The

cursor will be under the "Units" (temperature

4
 THE UNIT MUST BE
 TURNED OFF FOR
 10 SECONDS TO CLEAR
 AUXILIARY MEMORY

unit of measure selection) as shown by the highlight. Press the "up arrow" or "down arrow" button to change to "centigrade" if desired. Then press the "enter" button to move the cursor under the "Model" selection and press the "up

arrow or "down arrow" button to select the type of the unit. Then press the "enter" button. The words "Wait-Configuring" will appear on the bottom line. The alarm at this point be sounding. Ignore the alarm for now. After another brief moment the first page will appear from the I/O menu. Scroll down with the "down arrow" button and check the Inputs and Outputs. After scrolling past the 13th page, display #4 will prompt the user to turn off power for ten seconds. After reapplying power, a power loss alarm will sound. Clear the alarm and continue with setup of the controller as required.

IV. CONTROL OPERATIONS

This section provides the user with detailed explanations of the operational characteristics of the microprocessor.

A. Blower

The blower runs continuously if the following conditions are met:

1. 24 Volts is present on DI 5 (Enable)
2. The start up delay timer is not running
3. The unit is not in "STANDBY"
4. There are no FIRE or SMOKE alarms
5. The unit has not been placed in the "STOP" mode either locally or remotely

The blower runs when there is an "AIRFLOW ALARM". All other functions are shut down, but the unit continues to try to circulate air. If a belt is broken, shutting down all other functions prevents potential damage to the unit. If the airflow is marginal due to a slipping belt, because the microprocessor keeps trying to run the blower, keeps air circulating around the equipment the air conditioner is protecting.

B. Cooling Cycle

Compressor Cooling

In the cooling mode, the lead compressor stage comes on when the return temperature reaches 50% of the setpoint plus the dead-band. If the unit has hot gas bypass, the corresponding hot gas is enabled only with the compressor in the same circuit. If the return temperature reaches 99% of the setpoint plus the dead-band and the inter-stage delay timer has expired the lag compressor comes on. When the return temperature drops to 20% of the setpoint plus the dead-band the lag compressor will shut off as long as it's minimum-on timer has expired. When the return temperature drops to 1% of the setpoint plus the dead-band the lead compressor will shut off provided it's minimum on-timer has expired. If the unit has ECWS mode (External Chilled Water Supply), the compressor cooling cycle is inhibited if the chilled water sensor indicates that the incoming chilled water is below the setpoint or the flow switch indicates that there is no water flow. If in compressor cooling and the water flow switch indicates no water flow, ECWS mode will enable and inhibit compressor cooling and shut off the compressors, provided their minimum on-timers have expired.

Proportional Cooling (PC Mode)

Proportional cooling occurs to assist the compressor cooling if the proportional cool output is selected in setup and the chilled water sensor indicates that the incoming chilled water is below the maximum usable setpoint. Valve positioning is accomplished

though a series of “open” and “close” pulsed commands to the chilled water actuator. Upon power up the valve is run closed for 125% of the stroke that is factory programmed to ensure the valve is fully closed. When the return temperature exceeds the setpoint, the valve is driven open by a timed pulse of the OPEN output. This amount of time is proportional to the percent opening desired and the configured full stroke time. From the factory the proportional output is controlled by a proportional loop only. This control logic only increases the output in relation to the error signal developed between the setpoint and the return temperature. The logic can be changed in the field to permit proportional-integral loop. This can be done in the “Custom Setup”. If control is selected with Proportional-Integral (PI) logic, the signal will increase or decrease over time whenever the output is non-zero or there is a difference between the return temperature and the setpoint. Whenever the required percentage reaches 0% or 100% the valve is run for 125% of its stroke time to ensure the valve drives fully open or fully closed. After the stroke time has passed and 0% or 100% is still required, the controller “OPEN” or “CLOSED” output is periodically pulsed to keep it there. An analog voltage at the same time is available from AO1 (Analog Output 1). The starting voltage corresponds to 0% cooling and the start voltage plus the span voltage corresponds to 100% cooling.

ECWS Cooling

When the unit is configured for ECWS, proportional cooling is mutually exclusive of compressor cooling. When the proportional cooling input is enabled, the proportional cool output is selected for ECWS (as opposed to PC), the chilled water sensor indicates that the chilled water temperature is below the maximum usable temperature, there is water flow, and the return air temperature rises above the setpoint, ECWS cooling occurs. Valve positioning is accomplished through a series of open and close pulse commands to the chilled water valve actuator. Upon power up, the valve is run closed. Turning on the CLOSE output for 125% of the stroke programmed in the valve option screen ensures that the valve is fully closed. When the temperature increases above the cool setpoint, the valve is driven toward the open point by a timed pulse of the OPEN output. The amount of time the valve is driven is proportional to the percent opening desired and the configured time for a full stroke. The proportional output is controlled by proportional-integral logic that increases or decreases the output over time as long as the error signal is non-zero. The error is the difference between the return air temperature and the setpoint with the PI band equal to the cooling band. The integral time is the valve stroke time. Whenever the required percentage cooling reaches 0% or 100%, the valve is run for 125% of the programmed run time to ensure the valve is indeed fully closed or open. If the valve is commanded to either 0% or 100% and has run the 125% of the stroke time, the appropriate OPEN or CLOSE output is periodically pulsed to keep it there. An analog voltage is also available on analog output 1. The start voltage corresponds to 0% cooling and the start voltage plus the span voltage corresponds to 100% cooling.

C. Humidification

Humidification occurs when the relative humidity is less than the humidity setpoint minus the humidity band. Assuming that humidification is enabled, the digital humidity

output will turn on and remain on until the humidity reaches the humidity setpoint. If analog humidifier control is enabled, the analog output can be used to control a proportional humidifier. The output is at the minimum voltage when the humidity is at or above the humidification setpoint. The output increases proportionally as the humidity drops from the humidity setpoint.

D. Chilled Water/ECWS Dehumidification

Dehumidification using the optional chilled water coil operates in conjunction with the operation described above. The use of the PreCool or ECWS coil for dehumidification occurs when the calculated valve position for dehumidification is greater than the calculated valve position for cooling - cooling has precedence over dehumidification. The valve position is closed (0%) when the humidity is less than or equal to the dehumidification setpoint and increases proportionally to the open position (100%) until the humidity reaches the dehumidification setpoint plus the proportional dehumidification end point.

E. Heating Cycle

Electric Reheat

Electric Heating occurs when the return air temperature is below its heating setpoint and the heaters are enabled. When the temperature falls below the heat setpoint minus the heat band, the first stage of heat will come on. If there are more stages of heat, they will turn on one at a time for each degree the return air further drops. All stages of heat remain on until the return air temperature rises back to the setpoint.

Three-stage heat is an option on the two compressor versions where there are two physical heat stages, with stage one having twice the KW output than stage two. Thus stage one can supply 66% of the total available reheat and stage 2 can supply 33%. The sequence of turning on the stages as the temperature drops is: Stage 1 off and Stage 2 on (33% heat), then Stage 1 on and Stage 2 off (66%) and then Stage 1 and Stage 2 on (100%).

During dehumidification, the heat is used to reheat the air after it is cooled to drop out moisture using its normal algorithm.

Proportional Valve Reheat

When a proportional floating valve is selected for supplying reheat, the two outputs normally used for the two stages of electric heat are used as OPEN and CLOSE signals to a floating valve. Heating occurs when the return air temperature is below its heat setpoint and the heater is enabled. Upon power up, the valve is closed and run by

turning on the CLOSE output for 125% of the run time programmed in the valve option to ensure the valve is fully closed. When the temperature falls below the heat setpoint, the valve is driven toward the open point by a timed pulse of the OPEN output. The amount of time the valve is driven is proportional to the percent opening desired and the configured time for a full stroke. The proportional output is controlled by proportional-integral logic that increases or decreases the output over time as long as the error signal is non-zero. The error is the difference between the return air temperature and the setpoint with the PI band equal to the proportional heat band. The integral time is the valve stroke time. Whenever the required percentage heat reaches 0% or 100%, the valve is run for 125% of the programmed run time to ensure the valve is indeed fully closed or open. If the valve is commanded to either 0% or 100% and has run the 125% of the stroke time, the appropriate OPEN or CLOSE output is periodically pulsed to keep it there.

During dehumidification, the heat is used to reheat the air after it is cooled to drop out moisture using its normal algorithm for heating.

The display will show the percentage of heating in the center. Each time a new value is calculated that will cause the valve to move, the move is initiated and completed before a new value is calculated. This also applies to the closing at power up - the closing must complete before the valve is commanded to another setting.

INDEX

A

Analog Output Setup..... 21

B

Button Cluster 6

C

Clearing Alarm History 13
 Communications 17
 Component Status 11
 Compressor Cooling 23
 Compressor Setup 19

E

ECWS Cooling..... 24

H

Handling Alarms..... 8
 Help Key 7
 High and Low Return Temperature Alarms..... 9
 Humidity Control 18
 Humidity High and Low Alarms..... 10
 Humidity Sensor Offset..... 20
 Humidity Setpoint..... 10

N

Network Key..... 7
 Numeric Fields..... 7

O

Optional Sensors Status 11

P

Passwords: 16
 Power Up Screen 8
 Proportional Cooling 23

R

Return Air Conditions..... 11

S

Status Cluster 6

T

Temperature Control 18
 Temperature Sensor Offset 19
 Temperature Setpoint 9
 Temperature Units 17
 Toggling Fields 7

V

Viewing Alarm History 13

Revision History

Revision	Date	Revision	Description of Change
	1/15/99	N.C.	Initial Release
	2/2/99	A	Added DG5.0 Display Bitmap Image
	11/16/01	G.S.	Update Information
	2/1/02	S.B.	Reformat

1. Pin Out of Interface Board

		<u>Pin</u>	<u>Levels</u>	<u>Default Signal Definition</u>
DI 1	Digital Input			Low = Airflow Alarm
DI 2	Digital Input			High = Clogged Filter Alarm
DI 3	Digital Input			High = Water Detector Alarm
DI 4	Digital Input			Low = Comp. 1 L P, HWF Alarm
DI 5	Digital Input			High = System Enable
DI 6	Digital Input			Low = Comp. 2 L P, Door Alarm
DI 7	Digital Input			Low = WtrF12, WtrF13 Alarm
DI 8	Digital Input			High = Firestat Alarm
DI 9	Digital Input			High = Smoke Detector Alarm
DI 10	Digital Input			High = Humid, Frz, Comp. Lockout, Cond. Pump Alarm
DI 11	Digital Input			Low = Compressor 1 High Pressure Alarm
DI 12	Digital Input			Low = Compressor 2 High Pressure Alarm
AI 1	NTC Input			Return Temperature sensor
AI 2	NTC Input			CW supply T / Supply Temp
AI 3	NTC Input			CW Supply T / CW Return T
AI 4	NTC Input			HW Temp / Temp. 2
AI 5*	Analog Input			0 to 1 volt Return Humidity sensor
AI 6*	Analog Input			Not Used
AI 7**	Analog Input			Remote Temp
AI 8**	Analog Input			Remote Humidity
DO 1	Digital Output			Blower
DO 2	Digital Output			Electric Heat Stage 1 or Heat Valve Open
DO 3	Digital Output			Electric Heat Stage 2 or Heat Valve Close
DO 4	Digital Output			Humidifer
DO 5	Digital Output			Compressor 1 Liquid Line
DO 6	Digital Output			Compressor 1 Contactor
DO 7	Digital Output			Compressor 2 Liquid Line, Fan low speed, Hot Gas bypass
DO 8	Digital Output			Compressor 2 Contactor
DO 9	Digital Output			Unloader 1, Hot Gas 1, CL Valve open
DO 10	Digital Output			DEH/HG2, CL valve close, Unloader 2
DO 11	Digital Output			Common Alarm
DO 12	Digital Output			Not Used
DO 13	Digital Output			Not Used
AO 1	Analog Output			ECWS, CG Damper, PC, Cool, Heat, Humidifier
AO 2	Analog Output			ECWS, CG Damper, PC, Cool, Heat, Humidifier

Note:

* Analog inputs 5 and 6 are selectable for either 0-1 volt or 4-20 ma inputs. Jumper 2&3 for 0-1volt or 1&2 for 4-20ma. Also see Interface Board diagram.

** Analog inputs 7 and 8 are 4-20 ma inputs only.

J14 controls AI5

J15 controls AI6

MICROPROCESSOR LAYOUT

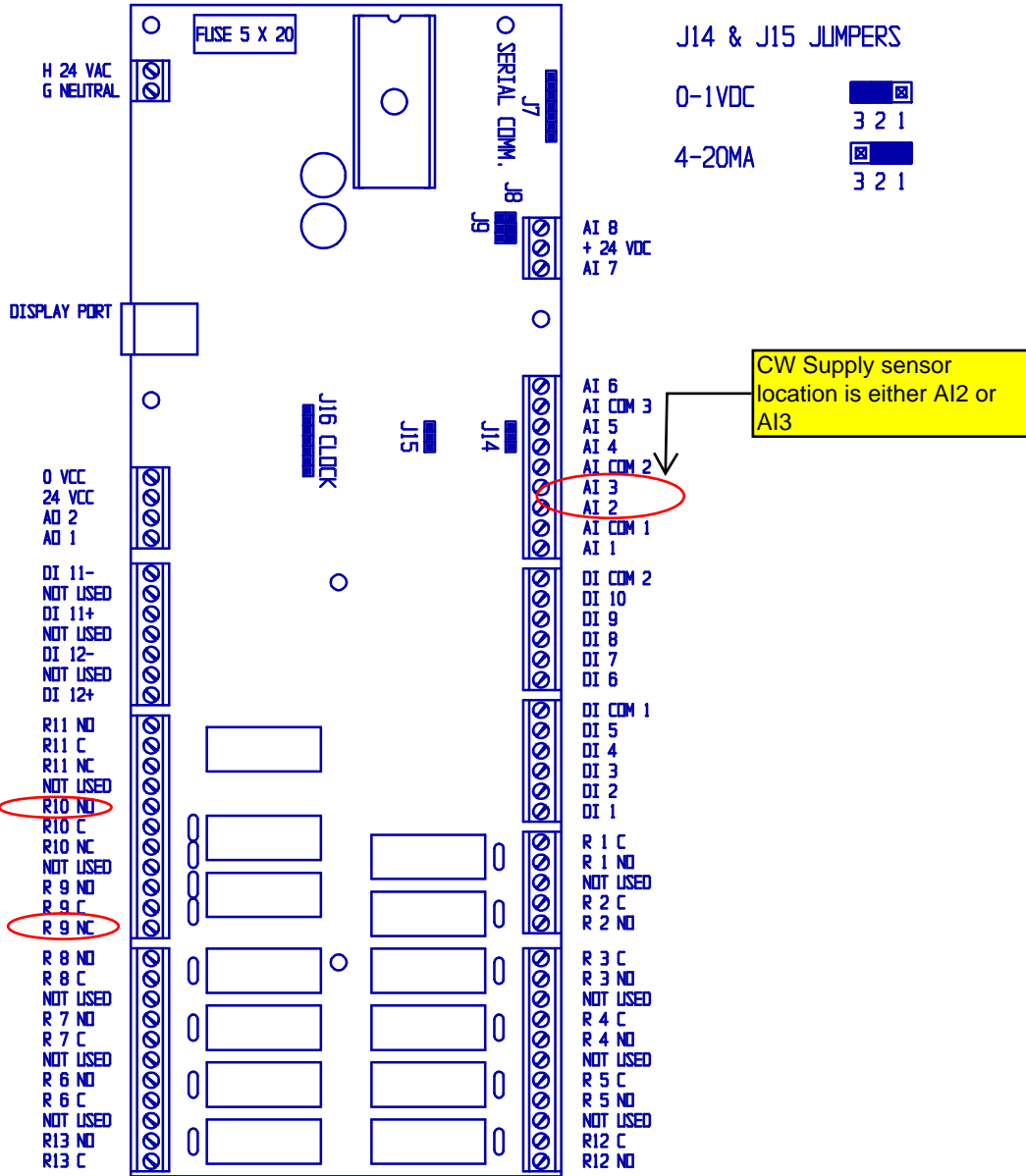

A. Display Cable

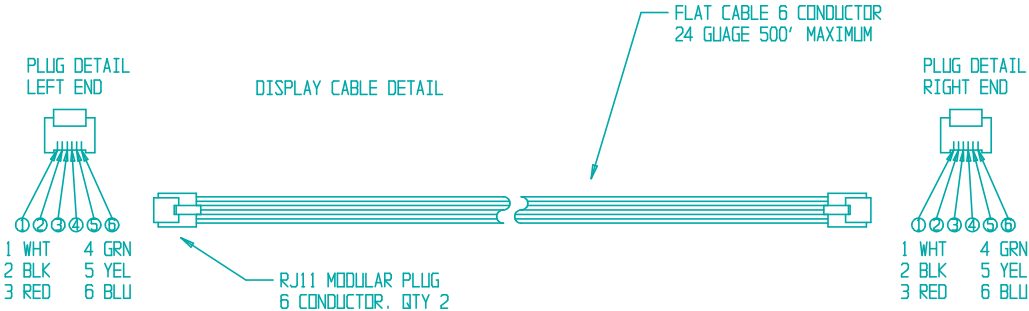

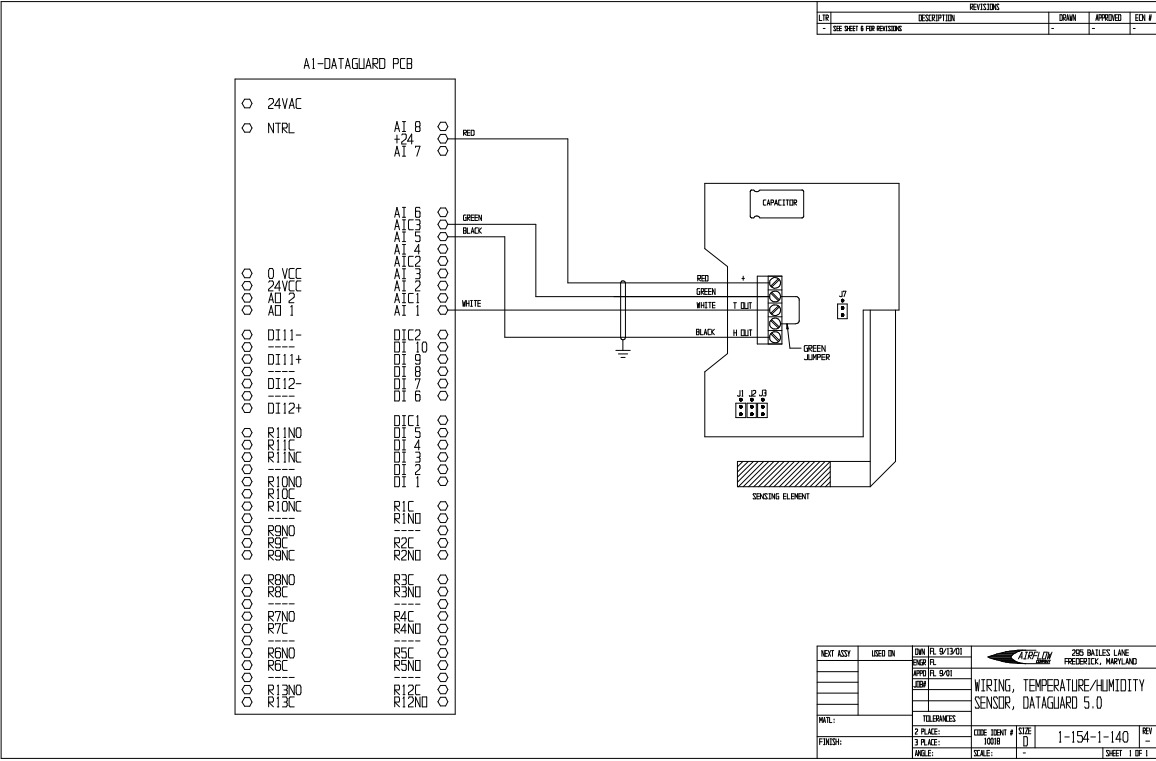

CONFIGURATION CHECKLIST

Notes:

1. numbers in parenthesis are Celsius
2. Ranges for Temperatures are scale independent (? F or ? C).
3. The given ranges do not imply that the unit will function properly over all of the values. Refer to the unit Installation, Start-up, Operation and Maintenance Procedures Manual for the unit's actual limits.

ACTUAL

<u>PARAMETER</u>	<u>DEFAULT</u>	<u>RANGE</u>
Start Up Delay	000 secs.	0 to 600 secs.
Fan Delay	11 secs.	0 to 600 secs.
Cool Setpoint	72.0? F(22.0)	12.0 to 95.0
Cool Band	2.0? F(1.0)	1.0 to 15.0
Return Temperature Offset	00.0? F (00.0)	-20.0 to + 20.0
DX Stages	2	0 to 2
Small Room Delay	000 secs.	0 to 999 secs.
Pump Down	OFF	ON or OFF
Minimum DX Off Time	300 secs.	180 to 999 secs.
Minimum DX On Time	300 secs.	180 tp 999 secs.
Return Temperature Sensor Alarm Common	ON	ON or OFF
Return Temperature Sensor Alarm Transfer	ON	ON or OFF
DX Lead/Lag	ON	ON or OFF
Lead/Lag Switch Time	10 hours	1 to 999 hours
Heat Setpoint	70.0? F(21.0)	0 to 85.0
Heat Band	2.0? F(1.0)	1.0 to 15.0
Heat Type	ELECTRIC	ELECTRIC or VALVE
Electric Heat Stages	2	0-2
Hot Water Minimum Temp.	150.0? F(65.0)	37.0 to 190.0
Hot Water Sensor Offset	00/0? F(00.0)	-20.0 to + 20.0
Heat Valve Stroke Time	60 seconds	10 to 180 secs.
Heat Valve Type	2 Way	2 Way or 3 Way
Hot Water Sensor Alarm Common	ON	ON or OFF
Hot Water Sensor Alarm Transfer	OFF	ON or OFF
Humidifier Control	ENABLED	ENABLED or DISABLED
Dehumidification Control	ENABLED	ENABLED or DISABLED
Humidification Setpoint	45.0%RH	10.0 to 85.0%RH
Dehumidification Setpoint	55.0%RH	10.0 to 95.0%RH
Humidification Band	5.0%RH	1.0 to 30.0%RH
Dehumidification Band	5.0%RH	1.0 to 30.0%RH
Humidity Sensor Offset	00.0%	-20.0% to +20.0%
Analog Humidity Start Voltage	00.0V	0.0 to +10.0V
Analog Humidity Span Voltage	10.0V	-10.0 to +10.0V
Analog Humidity Offset Voltage	0.0V	-2.0 to +2.0V
Return Humidity Sensor Alarm Common	ON	ON or OFF
Return Humidity Sensor Alarm Transfer	OFF	ON or OFF
Chilled Water Type	PC	PC or ECWS
Chilled Water Span	4.0? F(2.0)	1.0 to 15.0
Auto Flush Hours	100	10-99
Maximum Chilled Water setpoint	55.0? F(13.0)	1.0 to 85.0
Chilled Water Sensor Offset	00.0? F(00.0)	-20.0 to +20.0
Chilled Water Valve Type	3 Way	2 Way or 3 Way

<u>PARAMETER</u>	<u>DEFAULT</u>	<u>RANGE</u>	<u>SETTING</u>
Analog PC/ECWS Start Voltage	06.0V	0.0 to +10.0V	_____
Analog PC/ECWS Span Voltage	03.0V	-10.0 to +10.0V	_____
Analog PC/ECWS Offset Voltage	0.0V	-2.0 to +2.0V	_____
Chilled Water Sensor Alarm Common	ON	ON or OFF	_____
Chilled Water Sensor Alarm Transfer	OFF	ON or OFF	_____
Airflow Alarm Common	ON	ON or OFF	_____
Airflow Alarm Transfer	OFF	ON or OFF	_____
Airflow Alarm Closure	OFF	ON or OFF	_____
Airflow Alarm Enable	ON	ON or OFF	_____
Airflow Alarm Delay	10 seconds	10-600	_____
Clogged Filter Alarm Common	ON	ON or OFF	_____
Clogged Filter Alarm Transfer	OFF	ON or OFF	_____
Clogged Filter Alarm Closure	ON	ON or OFF	_____
Clogged Filter Alarm Enable	ON	ON or OFF	_____
Water Detector Alarm Common	ON	ON or OFF	_____
Water Detector Alarm Transfer	OFF	ON or OFF	_____
Water Detector Alarm Closure	ON	ON or OFF	_____
Water Detector Alarm Enable	ON	ON or OFF	_____
Comp. 1 Low Pressure Alarm Common	ON	ON or OFF	_____
Comp. 1 Low Pressure Alarm Transfer	OFF	ON or OFF	_____
Comp. 1 Low Pressure Alarm Closure	OFF	ON or OFF	_____
Comp. 1 Low Pressure Alarm Enable	ON	ON or OFF	_____
Comp. 2 Low Pressure Alarm Common	ON	ON or OFF	_____
Comp. 2 Low Pressure Alarm Transfer	OFF	ON or OFF	_____
Comp. 2 Low Pressure Alarm Closure	OFF	ON or OFF	_____
Comp. 2 Low Pressure Alarm Enable	ON	ON or OFF	_____
Water Flow Alarm Common	ON	ON or OFF	_____
Water Flow Alarm Transfer	OFF	ON or OFF	_____
Water Flow Alarm Closure	OFF	ON or OFF	_____
Water Flow Alarm Enable	ON	ON or OFF	_____
FireStat Alarm Common	ON	ON or OFF	_____
FireStat Alarm Transfer	OFF	ON or OFF	_____
FireStat Alarm Closure	ON	ON or OFF	_____
FireStat Alarm Enable	ON	ON or OFF	_____
Smoke Detector Alarm Common	ON	ON or OFF	_____
Smoke Detector Alarm Transfer	OFF	ON or OFF	_____
Smoke Detector Alarm Closure	ON	ON or OFF	_____
Smoke Detector Alarm Enable	ON	ON or OFF	_____
Comp. 1 High Pressure Alarm Common	ON	ON or OFF	_____
Comp. 1 High Pressure Alarm Transfer	OFF	ON or OFF	_____
Comp. 1 High Pressure Alarm Closure	OFF	ON or OFF	_____
Comp. 1 High Pressure Alarm Enable	ON	ON or OFF	_____
Comp. 2 High Pressure Alarm Common	ON	ON or OFF	_____
Comp. 2 High Pressure Alarm Transfer	OFF	ON or OFF	_____
Comp. 2 High Pressure Alarm Closure	OFF	ON or OFF	_____
Comp. 2 High Pressure Alarm Enable	ON	ON or OFF	_____
Comp. 1 Pump Down Alarm Common	ON	ON or OFF	_____
Comp. 1 Pump Down Alarm Transfer	OFF	ON or OFF	_____
Comp. 2 Pump Down Alarm Common	ON	ON or OFF	_____
Comp. 2 Pump Down Alarm Transfer	OFF	ON or OFF	_____
High Return Temp. Alarm Common	ON	ON or OFF	_____

<u>PARAMETER</u>	<u>DEFAULT</u>	<u>RANGE</u>	<u>SETTING</u>
High Return Temp. Alarm Transfer	OFF	ON or OFF	_____
High Return Temp. Alarm Enable	ON	ON or OFF	_____
High Return Temp. Alarm At	85.0? F(30.0)	0 to 100.0	_____
High Return Temp. Alarm Delay	300 secs.	1 to 600 secs.	_____
Low Return Temp. Alarm Common	ON	ON or OFF	_____
Low Return Temp. Alarm Transfer	OFF	ON or OFF	_____
Low Return Temp. Alarm Enable	ON	ON or OFF	_____
Low Return Temp. Alarm At	55.0? F	0.0 to 100.0	_____
Low Return Temp. Alarm Delay	300 secs.	1 to 600 secs.	_____
High Chilled Water Temp. Alarm Common	ON	ON or OFF	_____
High Chilled Water Temp. Alarm Transfer	OFF	ON or OFF	_____
High Chilled Water Temp. Alarm Enable	ON	ON or OFF	_____
High Chilled Water Temp. Alarm At	72.0? F	0 to 100.0	_____
High Chilled Water Temp. Alarm Delay	120 secs.	1 to 600 secs.	_____
Low Chilled Water Temp. Alarm Common	ON	ON or OFF	_____
Low Chilled Water Temp. Alarm Transfer	OFF	ON or OFF	_____
Low Chilled Water Temp. Alarm Enable	ON	ON or OFF	_____
Low Chilled Water Temp. Alarm At	40.0? F	0 to 100.0	_____
Low Chilled Water Temp. Alarm Delay	120 secs.	1 to 600 secs.	_____
High Hot Water Temp. Alarm Common	ON	ON or OFF	_____
High Hot Water Temp. Alarm Transfer	OFF	ON or OFF	_____
High Hot Water Temp. Alarm Enable	OFF	ON or OFF	_____
High Hot Water Temp. Alarm At	195.0? F	0 to 200.0	_____
High Hot Water Temp. Alarm Delay	120 secs.	1 to 600 secs.	_____
Low Hot Water Temp. Alarm Common	ON	ON or OFF	_____
Low Hot Water Temp. Alarm Transfer	OFF	ON or OFF	_____
Low Hot Water Temp. Alarm Enable	OFF	ON or OFF	_____
Low Hot Water Temp. Alarm At	100.0? F	0 to 200.0	_____
Low Hot Water Temp. Alarm Delay	120 secs.	1 to 600 secs.	_____
High Humidity Alarm Common	ON	ON or OFF	_____
High Humidity Alarm Transfer	OFF	ON or OFF	_____
High Humidity Alarm Enable	ON	ON or OFF	_____
High Humidity Alarm At	85.0%	0 to 100.0%RH	_____
High Humidity Alarm Delay	300 secs.	1 to 600 secs.	_____
Low Humidity Alarm Common	ON	ON or OFF	_____
Low Humidity Alarm Transfer	OFF	ON or OFF	_____
Low Humidity Alarm Enable	ON	ON or OFF	_____
Low Humidity Alarm At	30.0%	0 to 100.0%RH	_____
Low Humidity Alarm Delay	300 secs.	1 to 600 secs.	_____
Power Loss Alarm	ON	ON or OFF	_____
Blower Run Time Alarm	OFF	ON or OFF	_____
Blower Run Time Alarm Every	1000 hours	0 to 9999	_____
Comp. 1 Run Time Alarm	OFF	ON or OFF	_____
Comp. 1 Run Time Alarm Every	1000 hours	0 to 9999	_____
Comp. 2 Run Time Alarm	OFF	ON or OFF	_____
Comp. 2 Run Time Alarm Every	1000 hours	0 to 9999	_____
Humidifier Run Time Alarm	OFF	ON or OFF	_____
Humidifier Run Time Alarm Every	1000 hours	0 to 9999	_____
Setpoint Password	0000	0000-9999	_____
Service Password	0000	0000-9999	_____
Supervisor Address	00	00-100	_____