



NetworkAIR[®] FM Precision Air Conditioner

Chilled Water

Operation and Maintenance





This manual is available in English on the enclosed CD.

Dieses Handbuch ist in Deutsch auf der beiliegenden CD-ROM verfügbar.

Ce manuel est disponible en français sur le CD-ROM ci-inclus.

Questo manuale è disponibile in italiano nel CD-ROM allegato.

Instrukcja Obsługi w języku polskim jest dostępna na CD.

Инструкция по использованию на русском языке прилагается на диске (CD).

Deze handleiding staat in het Nederlands op de bijgevoegde cd.

Este manual está disponible en español en el CD-ROM adjunto.

O manual em Português está disponível no CD-ROM em anexo.

您可以从包含的 CD 上获得本手册的中文版本。

本マニュアルの日本語版は同梱の CD-ROM からご覧になれます。

Contents

| | |
|---|-----------|
| Operation | 1 |
| Display Interface | 1 |
| Using the Display | 2 |
| Scrolling status screens | 2 |
| Main menu screen | 3 |
| Navigating the interface | 3 |
| Password entry | 4 |
| Start the System | 4 |
| Change settings | 4 |
| Stop the System | 5 |
| Set Up System Configuration | 6 |
| System options | 6 |
| System delays | 8 |
| Building management | 9 |
| Sensor setup | 9 |
| Options for Fluid-Cooled Modules | 11 |
| Valve types | 12 |
| Actuator types | 12 |
| Coil fluid temp activation threshold and deadband | 13 |
| Set Up Contacts and Relays | 14 |
| Input contacts | 14 |
| Output relays | 15 |
| Set Up Module Configuration | 17 |
| Configure Module | 17 |
| Alarm detectors | 17 |

| | |
|---|-----------|
| Set Up Module Control | 18 |
| Calibrate airflow > manually | 18 |
| Calibrate airflow automatically | 19 |
| Reset variable frequency drive | 19 |
| Reset humidifier | 19 |
| Set up humidifier | 20 |
| Reset compressors | 20 |
| | |
| Control the Environment | 21 |
| How the modes work | 21 |
| Setpoints | 22 |
| Deadbands | 23 |
| Modes | 23 |
| Essential functions | 23 |
| PID controls | 24 |
| How to tune the PIDs | 25 |
| Humidification sensitivity | 26 |
| | |
| Set Up Alarms | 27 |
| Temperature alarms | 27 |
| Humidity alarms | 27 |
| Maint intervals | 28 |
| Alarm delays | 28 |
| Coil fluid thresholds | 28 |
| | |
| Set Up Group | 29 |
| Group config | 29 |
| Group settings | 30 |
| System failure events | 31 |
| | |
| Set Up the Display | 32 |
| Password & Time-out | 32 |
| Date and time | 32 |
| Temperature and pressure units | 33 |
| Adjust display | 33 |
| How to update the firmware | 33 |
| Reset to defaults | 34 |
| Product data | 34 |
| | |
| Set up Network Configuration | 35 |
| Network config | 35 |

| | |
|-----------------------------------|-----------|
| View Status Readings | 36 |
| Scrolling status screens | 36 |
| Module status | 36 |
| System status | 37 |
| Group status | 38 |
| View Event Log | 38 |
| View Log | 38 |

| | |
|--|-----------|
| Respond to Alarms. | 39 |
| Major or minor alarm LEDs | 39 |
| Control beeper | 39 |
| View active alarms | 39 |
| Clear active alarms | 40 |
| Reset sys failure | 40 |
| Alarm messages and suggested actions | 41 |

Network Management Card..... 47

| | |
|--|-----------|
| Quick Configuration | 47 |
| Overview | 47 |
| TCP/IP configuration methods | 47 |
| APC Device IP Configuration Wizard | 48 |
| BOOTP & DHCP configuration | 48 |
| Local access to the control console | 51 |
| Remote access to the control console | 52 |
| Control console | 53 |

| | |
|--|-----------|
| How to Access a Configured Module | 54 |
| Overview | 54 |
| Web interface | 54 |
| Telnet/SSH | 55 |
| SNMP | 55 |
| FTP/SCP | 56 |

| | |
|---|-----------|
| How to Recover From a Lost Password. | 57 |
|---|-----------|

| | |
|--------------------------------------|-----------|
| How to Upgrade Firmware | 59 |
|--------------------------------------|-----------|

Maintenance 61

Monthly Preventive Maintenance 61

- Environment 61
- Cleanliness 62
- Mechanical 62
- Electrical 62

Quarterly Preventive Maintenance 63

- Mechanical 63
- Electrical 63
- Functional tests 64

Semi-Annual Preventive Maintenance 65

- Cleanliness 65
- Electrical 65
- Functional tests 65

Troubleshooting 66

- Refrigeration 66
- Electrical 68

Warranty 69

Limited Product Warranty for APC Products 69

- APC product covered 69
- Terms of warranty 69
- Non-transferable Warranty extends to first purchaser for use . 69
- Assignment of warranties 70
- Drawings, descriptions 70
- Warranty claims procedure 70
- Exclusions 70

Warranty Procedures 72

- Labor 72
- Parts 72

Operation

Display Interface

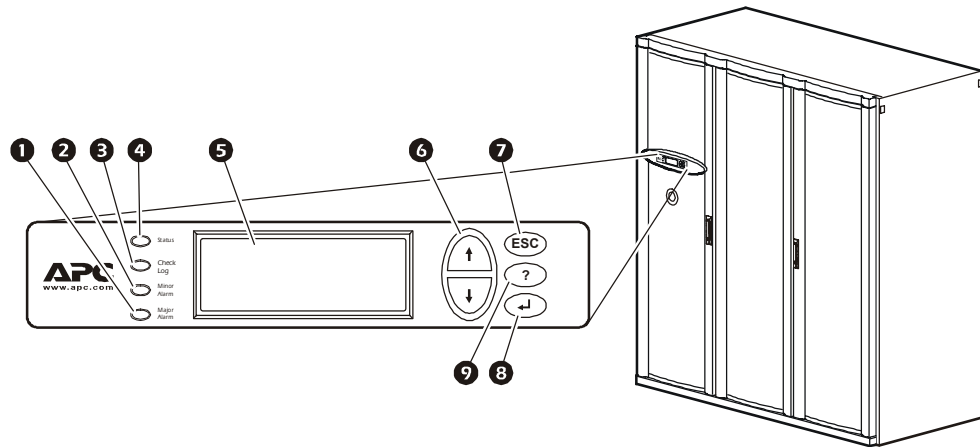

| Item | Function |
|--------------------------------|--|
| 1 Major Alarm LED | When red, a major alarm condition exists. |
| 2 Minor Alarm LED | When yellow, a minor alarm condition exists. |
| 3 Check Log LED | When yellow, at least one new major alarm, minor alarm, or event has occurred. |
| 4 Status LED | When green, the Module is on. |
| 5 Liquid Crystal Display (LCD) | View alarms, status data, instructional help, and configuration items. |
| 6 Up and down arrow keys | Select menu items and access information. |
| 7 ESC key | Return to the previous screen. |
| 8 ENTER key | Open menu items and input changes to System and Module settings. |
| 9 HELP key | Display context-sensitive help. Press the HELP key for information about each option on the screen and for instructions on how to perform tasks. |

Using the Display

The first time you apply power to the NetworkAIR FM Precision Air Conditioner the display initializes, and runs an LED and alarm-tone test.

Scrolling status screens

After start-up, the interface displays the firmware revision number (if the fast start-up is disabled). The display interface then scrolls automatically and continuously through nine screens of status information.

| Status Screen Name | Status Information Displayed |
|-------------------------|---|
| Control Temp & Humidity | <ul style="list-style-type: none"> • Temperature and Humidity at the sensors being used to control the environment • Remote Temperature and Humidity (optional) • Humidity Control Method (dew point or relative humidity) |
| Cool/ Dehum Demands | <ul style="list-style-type: none"> • Cool Demand % • Note: If you have more than one cooling coil (i.e., DX and MultiCool), the demand is split. • Dehumidify Demand % • Actual Output % |
| Reheat Demand | <ul style="list-style-type: none"> • Reheat Status: On/Off (Steam, hot water, or hot gas only) • Reheat Demand % (Electric SCR only) |
| Humidify Demand | <ul style="list-style-type: none"> • Humidify Demand % • Humidify Actual % |
| Group Status | <ul style="list-style-type: none"> • Number of Systems • Setpoint Share: On/Off • Demand Fighting: On/Off |
| Group Status | <ul style="list-style-type: none"> • System # • Role • State |
| Active Alarms | <ul style="list-style-type: none"> • Alarm number • Module identifier • Alarm name • Time stamp |
| Setpoints | <ul style="list-style-type: none"> • Cool °C (or °F) • Reheat °C (or °F) |
| Setpoints | <ul style="list-style-type: none"> • Dehumidify % RH • Humidify % RH |

Press the up or down arrow key to interrupt the automatic scrolling and view a specific status screen. To return to the scrolling status screens, press the ESC key from the main menu screen.

Main menu screen

On any top-level status screen, press the ENTER or ESC key to open the main menu screen.



Note

If the display interface is inactive for ten minutes (the default delay), it returns to the scrolling status screens. To change this delay, use the **time-out** setting under the **Password** menu.

Navigating the interface

Selector arrows. Press the up or down arrow key to move the selector arrow **1** to a menu option or setting. Press the ENTER key to view the selected screen or modify the setting.

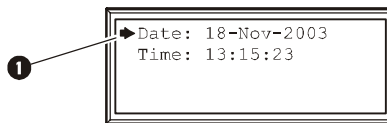

Continue arrows. Continue arrows **2** indicate that additional options or settings are available on a menu or status screen. Press the up or down arrow key to view the additional items.

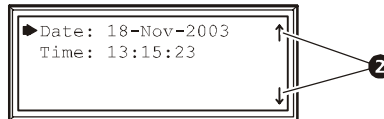

Input arrows. Input arrows **3** next to a selected setting indicate that the setting can be modified by pressing the up or down arrow key. Press the ENTER key to save the change or the ESC key to cancel the change.

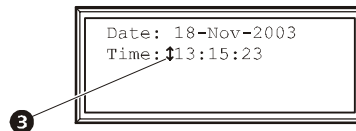

Password entry

The Module has two levels of password protection:

- **User password** for users who need to change basic and environmental settings.
- **Service password** for users who need to modify settings that control the components in the Module or change advanced options.

When you try to change any of the settings, the display prompts you to enter your password.

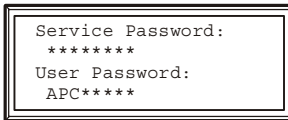

The default value for both the **User** and **Service** password is **APC** (upper case). To enter your password, use the up or down arrow keys to scroll through the alphabet. Press the ENTER key to select the current letter and move the cursor to the next letter position. After selecting the last letter of your password, press the ENTER key once more to submit your password.



Note

Passwords are case-sensitive.

Start the System

Path: Main Menu > On/Off

To start the System, select the **On/Off** option on the main menu and change the setting to **On**. The System will run according to the current settings under **Control Environment**.

Change settings

Use the up or down arrow key to move the selector arrow to the setting that you wish to change, and press the ENTER key.

- **List of choices.** If the setting is a list of choices, an input arrow is displayed next to the setting. Press the up or down arrow key to select the choice you want, and then press the ENTER key to exit the input mode and save the setting. Press the ESC key to exit without saving.
- **Numbers or text fields.** If the setting is a number or text field, use the arrow keys to select the value of the first character and press the ENTER key to move to the next. Press the ENTER key after the last character is set to exit the input mode and save the setting. Press the ESC key to exit without saving.

Stop the System

Path: Main Menu > On/Off

To stop the System, select the **On/Off** option on the main menu and change the setting to **Off**.



Note

Change the setting to **Off** to shut down all modes of operation and the blower fan; the display and the controller continue to receive power.

For Systems with electric reheat, the blower fans may continue to operate for up to 60 seconds to purge heat from the System.

Set Up System Configuration

The System configuration options are set at the factory and may be modified during the commissioning of the Modules in the System.



Warning

Changing the settings incorrectly can cause serious malfunctions and damage to your System. Only qualified service personnel should make changes to these settings.



Note

The System configuration settings do not all apply to the NetworkAIR FM Precision Air Conditioner.

System options

Path: Main > Setup > System # > System Config > System Options

The **System Options** menu contains settings that identify the hardware installed in this System and the methods used to control that hardware.

Mains In. Indicate the primary operating voltage required for this System. The configuration is based on the voltage of the electrical components in the System, and is printed on the nameplate attached to the door on the left side of the electrical box.

UPS In. Indicate the operating voltage rating for the back-up power supply. The configuration is based on the voltage of the electrical components in the System, and is printed on the nameplate attached to the door on the left side of the electrical box.

Coil Cfg. Indicate the coil configuration installed in the Modules of this System. Available coil configurations include:

- Chilled liquid only — Chilled water coil only
- DX — Direct expansion (DX) coil
- Econ — Economizer and DX coils
- MultiCool — MultiCool (chilled water) and DX coils

Humid Ctrl. Indicate the humidity control method. The System can control the humidity based on the following:

- Relative humidity (**RH**) of the return air.
- Dew point (**DewPt**) of the return air. The dew point method corrects for hotspots near the environmental sensors.



Note

The System will always use the dew point method, regardless of this setting:

- When using the remote sensor readings to control the room environment.
- When the System is part of a redundant Group.

PCIOMs. Set the number of Programmable Customer Input/Output Modules (PCIOMs) installed in the user interface box. This setting controls the number of input contacts and output relays available in the **Input/Output** menu.



See “Set Up Contacts and Relays” on page 14 to set up the contacts and relays from the display interface.



See also

See the *Installation Manual* to connect the contacts and relays to the Main Module.

Modules in Sys. Indicate the number of Modules in this System. Up to three modules can be joined together to form a single System.

Air Filter. Set the type of air filters installed in the Modules of this System to either standard or high efficiency.

Fast Startup. Set the System to bypass the normal start-up sequence and delay the next time power is applied to the System.



Note

Fast Startup is not recommended for typical installations.

Airflow. Set the airflow pattern for the modules in this System:

- Up
- Down
- Horizontal

Rej. Method. Indicate the fluid used for heat of rejection by the refrigeration system:

- Air
- Water
- Glycol



Note

The rejection method setting applies only to configurations using compressors. In configurations using only chilled water the rejection method does not apply.

Dehum Cap. The **Dehumidify Capacity** setting does not apply to Systems without compressors. For Systems with compressors (direct expansion), the dehumidify mode can be set to use half capacity or full capacity of the cooling coil.

- Half capacity—uses one compressor and half of the cooling coil to dehumidify. Rooms with small heat loads should use half capacity to avoid over-cooling while dehumidifying.
- Full capacity—uses the entire coil and both compressors.

Module Rot. The **Module Rotation** setting does not apply to Systems without compressors. For Systems with compressors (direct expansion), the System rotates the order in which the compressors are engaged to equalize the total number of hours that each compressor runs. Set the number of hours to run each compressor before switching their order. A setting of zero indicates that the order in which the compressors are engaged should not be changed.

Refrigerant. The **Refrigerant** setting applies only to Systems with compressors. Set the type of refrigerant charge used in the direct expansion refrigeration system.

Suction Pressure Compensation. The **Suction Pressure Compensation** setting does not apply to Systems without compressors. For Systems with compressors (direct expansion), **Suction Pressure Compensation** allows the System to slow the blowers if the suction pressure becomes too high. Use this setting if you are using the FM in a high-density application.

System delays

Path: Main > Setup > System # > System Config > System Delays

The System delays protect the Modules in the System from excessive wear and damage, and keep the modes from working against each other.

Comp Min ON. The **Comp Min ON** setting does not apply to Systems without compressors. For Systems with compressors (direct expansion), the delay begins when the compressor engages, and then prevents the compressor from disengaging until the delay has expired. It protects the compressors from rapidly cycling between on and off and pushing all of their lubricating oil out into the refrigerant line.



Caution

Reducing the **Comp Min ON** delay can shorten the lives of your compressors by causing excessive wear and damage.

Comp Min OFF. The **Comp Min OFF** setting does not apply to Systems without compressors. For Systems with compressors (direct expansion), the delay begins when the compressor disengages, and then prevents the compressor from engaging until the delay has expired. It protects the compressors from rapidly cycling between on and off and pushing all of their lubricating oil out into the refrigerant line.



Caution

Reducing the **Comp Min OFF** delay can shorten the lives of your compressors by causing excessive wear and damage.

Cndsr Vlv Dly. The **Cndsr Vlv Dly** setting does not apply to Systems without compressors. For Systems with compressors (direct expansion), the condenser fluid valve close delay begins when the compressors disengage, and then keeps coolant flowing through the heat exchanger until the delay expires. Once the delay expires, the condenser fluid valve closes.

Intrstg Dly. The **Intrstg Dly** setting does not apply to Systems without compressors. For Systems with compressors (direct expansion), the interstage delay begins when the first compressor (stage 1) in a Module engages. It prevents a second compressor (stage 2) in a System from engaging until the delay has expired.

Start-up Dly. The **Start-up Delay** applies to all System configurations. The delay begins when the System is started and initialized. The System cannot begin operation until this delay has expired. Use the start-up delay to restart equipment sequentially in your room after a power loss.

Mode Dly. The **Mode Delay** setting applies to all System configurations. The delay begins when the blowers start. It allows the sensors to obtain an accurate reading of the room conditions, and the System to check for major alarms before engaging environmental control functions.

Comm Loss Shutdown Dly. The **Communication Loss Shutdown Delay** applies to Multi-Module Systems. The delay begins when an Expansion Module loses communication with the Main Module of a System. If communication is not restored before the delay expires, the Expansion Module shuts down. Set the delay for up to twenty-four hours, or select **Disabled** to cause the Expansion Modules to remain operating if communication with the Main Module is lost.

Building management

Path: Main > Setup > System # > System Config > Building Management

If you are using a building management system with your NetworkAIR FM Precision Air Conditioner you must set the following values:

Address. The address of the Main Module on the RS-485 bus for a building management system.

Baud Rate. The bus speed for the RS-485 bus.

Parity. The parity for the RS-485 bus.

Stop Bits. The stop bits for the RS-485 bus.



See also

See the *Installation Manual* to wire the electrical connections to the RS-485 bus for connecting to a building management system.

Sensor setup

Path: Main > Setup > System # > System Config > Sensor Setup

Specify the set of sensors the NetworkAIR FM Precision Air Conditioner will use to calculate the environmental control demands. These settings apply only to NetworkAIR FM Systems.

Temp/Hum Snsrs. Choose the set of temperature and humidity sensors the controller will use when determining the need for environmental control. The return sensors and the remote sensor string are available.

Dflt Snsrs. Choose the sensor group that the System will use when the System settings are reset to their default values.

Rmt Snsr Data. When determining the environmental controls, choose the measurement from the remote sensors for the controller to use.

- **Max** — Use the value reported by the remote temperature and humidity probe reporting the maximum value on the remote sensor string.
- **Avg** — Use the average of all of the remote temperature and humidity probe values.

Options for Fluid-Cooled Modules

Water-cooled Modules have settings for the valves and piping needed to accommodate the heat of rejection method. The NetworkAIR FM Precision Air Conditioner provides cooling by using a fluid coil without a compressor.

The following settings apply to each type of fluid-cooled Module. See the rest of this section for a description of each setting.

| Fluid-Coil Type | Applicable Settings |
|------------------------|---|
| Chilled Water | <ul style="list-style-type: none">• Coil Cfg (System Configuration)• Flow Switch• Coil Fluid Valve• Coil Fluid Valve Actuator• Coil Fluid Temp Activation<ul style="list-style-type: none">– Threshold– Deadband• PID Control (Control Environment) |

Valve types

Path: Main > Setup > System # > System Config > Valve Types

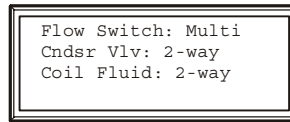

Set the type of valves installed in your piping system. Each valve can be either two-way or three-way. Economizer-equipped Systems use three-way valves.

Flow Switch. Set the location of the optional flow switch in this System. The flow switch detects whether there is adequate liquid coolant (water) flow to maintain coil operation.

The **Flow Switch** setting indicates where the flow switch is installed:

- **DX/ECON**, for the liquid line entering the heat exchanger (to maintain head pressure in DX Systems)
- **MC/CW**, for the chilled water input to the MultiCool coil or chilled water coil (Systems using chilled water only)
- **None**, for air-cooled Modules with no MultiCool coil

Cndsr Vlv. The condenser fluid valve controls the flow of coolant into the heat exchanger or to the Economizer coil in direct expansion Systems. Set the condenser fluid valve as either a two- or three-way valve.

Coil Fluid. The coil fluid valve controls the flow of coolant to the MultiCool, Chilled Water, or Economizer coil. Set the coil fluid valve as either a two- or three-way valve, depending on the configuration.

Actuator types

Path: Main > Setup > System # > System Config > Actuator Types

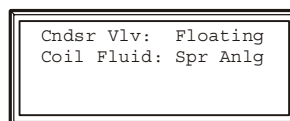

Cndsr Vlv. Set the type of condenser valve actuator as **Floating** or **None**. The condenser valve is not present in Modules that use only chilled water for cooling.

- **Floating Control:** maintains the position of the valve when the power is off.
- **None:** indicates that no condenser valve is installed. Air-cooled Systems without external water piping do not require a condenser valve actuator.

Coil Fluid. Set the Coil Fluid valve actuator to **Floating**, **Spr Anlg**, or **None**.

- **Floating Control:** maintains the position of the valve when the power is off.
- **Spring (Return) Analog:** closes the valve when the power is off.
- **None:** indicates that the Module does not have a MultiCool, Chilled Water, or Economizer coil.

Coil fluid temp activation threshold and deadband

Path: Main > Setup > System # > System Config > Coil Fluid Options

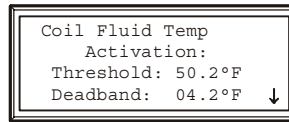

The **Coil Fluid Options** help control the optional MultiCool coil or Economizer coil in equipped Systems. Set the temperature threshold and deadband for using the MultiCool coil or the Economizer coil. The System will compare the actual coolant temperature with the setpoint and deadband to determine if the coolant is at a temperature low enough to operate the coils.



Note

The Coil Fluid Temp Activation threshold and deadband do not apply to Modules that use only chilled water for cooling.

Coil Fluid Temp Activation: Threshold. Set the coil fluid activation threshold. The coolant temperature must be below the threshold to use the optional MultiCool coil or Economizer coil.

Coil Fluid Temp Activation: Deadband. Set the MultiCool or Economizer activation deadband. The deadband is the sensitivity range above the **Coil Fluid Temp Activation: Threshold** that determines when the controller will stop using the MultiCool coil or Economizer coil and when it will reengage the coil. For example, if the threshold is 50 °F and the deadband is 4 F° (fahrenheit degrees), the controller will disengage the MultiCool coil or Economizer coil when the coolant temperature exceeds 54 °F and will not reengage the coil until the coolant temperature reaches 50 °F.

Set Up Contacts and Relays

The System can monitor external contact closure events. Possible applications include:

- Magnetic contact switches
- Window foil
- Tamper switches
- Heat detectors
- Water sensors
- Pressure sensors
- Building smoke and fire detection systems

You can set input contacts to cause alarm conditions based on their current state and a user-defined normal state. Output contacts can map internal alarms and events to outside devices.



See also

See the *Installation Manual* to connect contacts and relays to your Programmable Customer Input/Output Module (PCIOM).

Input contacts

Path: Main > Setup > System # > Input/Output > Input Contacts

| |
|---------------|
| Input: 01of16 |
| Name: Input1 |
| Normal: Open |
| Status: Open |

| |
|--------------|
| Delay: 030 s |
| Alarm Map: |
| Major Alarm |

Each Main Module supports up to 16 user-defined input contacts. Each contact monitors a sensor and responds to changes in the state of the sensor (open or closed).

Name. Provide a unique name for each input contact.

Normal. Choose the normal state of the sensor. If the state changes, the controller takes the action defined by the **Action** setting.

Delay. Set how long the contact should be out of its normal state before the controller takes action (controlled by the **Action** setting).

Action. Set the System controller to respond to the change of status for an input in one of the following ways:

| Map | Description/Function |
|----------------------|---|
| Status Only | Displays the event on the Active Alarms screen. Status-only events are not logged. |
| Minor Alarm | Activates the Warning LED and the alarm beeper. It also creates an entry in the event log. |
| Major Alarm | Activates the Alarm LED and the alarm beeper. It also creates an entry in the event log. |
| Remote Run/Stop | Shuts down the Modules normally, waiting for delay timers. |
| Nonessential Lockout | Deactivates modes set as nonessential and continues operation. |
| Immediate Shutdown | Shuts down the Modules immediately. It does not wait for the blower delay or compressor timers. |

Output relays

Path: Main > Setup > System # > Input/Output > Output Relays

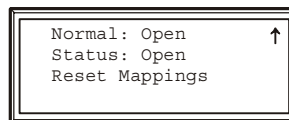
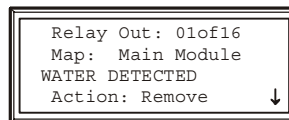

The Main Module supports up to 16 user-defined output relays. Output relays respond to internal alarms and events by changing state to notify outside devices.

Relay Out. Choose the relay number to view or modify.

Map. Choose alarms or events to map to this relay:

- The first line of the map field displays the location of the event that is mapped to this relay. It can be a System, Main Module, Expansion Module 1, or Expansion Module 2 event.
- The second line displays the name of the event mapped to this relay.



Any input contact and output relay available in this System can be mapped to this relay.

Action. The **Action** field changes as you scroll through the list of events that can be mapped to this relay. **Remove** indicates that the event is already associated with this relay. **Add** indicates that the event is not associated with this relay. Press the ENTER key and change the setting to map the displayed event to this relay or remove the displayed event from the list of events mapped to this relay.

Normal. Set the normal state for this relay. If the state of an alarm or event mapped to this relay changes from the normal state, the relay also changes state.

Reset Mappings. Clear all of the output mappings back to their default settings.

Set Up Module Configuration

The Module configuration settings help the controller determine which components are available and how the Module should operate.



The settings in the **Module Configuration** menu are defined at the factory. Changing the settings incorrectly can cause serious malfunctions and damage to your System. Only qualified service personnel should make changes to these settings.

Configure Module

Paths: **Main > Setup > Module > Main Module > Module Config > Config Module**
Main > Setup > Module > Expansion Module 1 > Module Config > Config Module

The **Config Module** menu contains settings that define the optional equipment available in the Module.

Output Cap. Indicate the output capacity of the Module, in kilowatts.

Heater. Indicate the type of heating equipment installed to run the reheat mode.

Humid. Indicate the type of humidifier equipment installed to run the humidification mode.

Conds Pump. Indicate the presence of a condensate pump. The pump feeds the condensate from the reservoir into the drain.

Blower. Indicate the type of blower controller for this Module.

Elec Heater Cap. Indicate the capacity of the electric heater.

Alarm detectors

Paths: **Main > Setup > Module > Main Module > Module Config > Set Alarm Detectors**
Main > Setup > Module > Expansion Module 1 > Module Config > Set Alarm Detectors

The **Set Alarm Detectors** settings indicate the presence of sensors in the Modules:

- **Smoke** — Indicate whether a smoke detector is installed in the Module.
- **Fire** — Indicate whether a fire detector (thermal sensor) is installed in the Module.
- **Water** — Indicate whether water leak detectors (loop detectors) are installed in the Module.

Set Up Module Control

The Module Control options are configured and tuned during the commissioning of each Module.



The settings in the **Module Control** menu are defined at the factory. Changing the settings incorrectly can cause serious malfunctions and damage to your System. Only qualified service personnel should make changes to these settings.

Calibrate airflow > manually

Paths: Main > Setup > Module > Main Module > Module Control > Adjust Blower
 Main > Setup > Module > Expansion Module 1 > Module Control > Adjust Blower



Note

Calibrate the airflow when the coil is dry: disable the Cool and Dehumidify modes before calibrating.



Note

The System must be on and the blowers must be operating to calibrate the airflow manually. If either condition does not exist, the display will prompt you to turn on the System and blowers.

Nom Coil DP. Set the nominal coil differential pressure.

Blower Spd. Adjust the frequency of the blower.

Coil DP. Displays the coil differential pressure at the bottom of the screen. As the blower frequency is adjusted, the coil differential pressure will change. The table below gives the recommended coil differential pressure at various airflow rates.

Coil Differential Pressure Values

| Model | 8000 CFM | 7750 CFM | 7500 CFM | 7250 CFM | 7000 CFM | 6750 CFM | 6450 CFM |
|--------|----------|----------|----------|----------|----------|----------|----------|
| 3 Rows | 0.28 | 0.27 | 0.25 | 0.24 | 0.23 | 0.21 | 0.20 |
| 4 Rows | 0.37 | 0.35 | 0.33 | 0.32 | 0.30 | 0.28 | 0.26 |

All values are displayed in inches water column ("WC).

Calibrate airflow automatically

Paths: Main > Setup > Module > Main Module > Module Control > Adjust Blower
Main > Setup > Module > Expansion Module 1 > Module Control > Adjust Blower

Nom Coil DP. Set the nominal coil differential pressure.

Start/Abort. Start the automatic calibration. If calibration is in progress, this line displays **Abort**.

Coil DP. Displays the coil differential pressure at the bottom of the screen. As the blower frequency is adjusted, the coil differential pressure will change. When the Coil DP values matches the Nom Coil DP value, the System will display **Calibration Complete**. If the System cannot align the two values, the System will display **Calibration Failed** after two minutes. You must manually calibrate the airflow if automatic calibration fails.

Reset variable frequency drive

Paths: Main > Setup > Module > Main Module > Module Control > Reset VFD #
Main > Setup > Module > Expansion Module > Module Control > Reset VFD #

The **Reset VFD** option resets the variable frequency drive (VFD). The drive shuts down during a **VFD # Fault Tolerance Exceeded** alarm. The alarm occurs when the VFD detects three faults within thirty minutes. Use this function to restart the drive manually when the alarm condition is resolved.



VFD Fault Tolerance Exceeded alarms indicate a problem with the VFD. Check the event log for other VFD alarms before resetting the VFD.

Reset humidifier

Paths: Main > Setup > Module > Main Module > Module Control > Reset Humidifier
Main > Setup > Module > Expansion Module > Module Control > Reset Humidifier

The **Reset Humidifier** option resets the humidifier. The humidifier shuts down during a **Humidifier Fault Tolerance Exceeded** alarm. The alarm occurs when the humidifier detects three faults within thirty minutes. Use this function to restart the humidifier manually when the alarm condition is resolved.



Humidifier Fault Tolerance Exceeded alarms indicate a problem with the humidifier. Check the event log for other humidifier alarms before resetting the humidifier.

Set up humidifier

Paths: Main > Setup > Module > Main Module > Module Control > Set up Humidifier
Main > Setup > Module > Expansion Module > Module Control > Set up Humidifier

The **Set up Humidifier** option controls the steam-electrode humidifier mode.

Humidifier Mode. The steam-electrode humidifier can be set to one of three modes:

- **Off** — Removes power from the electrodes in the humidifier, while the cylinder remains filled.
- **Drain** — Removes power from the electrodes and drains the cylinder.
- **Auto** — Applies power to the humidifier and sets the humidifier to operate according to the Module controller.



Note

The steam-electrode humidifier must be in **Auto** mode to operate.

Reset compressors

Paths: Main > Setup > Module > Main Module > Module Control > Reset Compressors
Main > Setup > Module > Expansion Module > Module Control > Reset Compressors

The **Reset Compressors** option resets the compressors after an alarm. It only applies to Modules with compressors and a DX coil. The compressors shut down during a **Suction Pressure Low** alarm. Use this function to restart the compressors manually when the alarm condition is resolved.



Caution

Suction Pressure Low alarms indicate a problem with the refrigeration system. Check the event log for other alarms before resetting the compressors.

Control the Environment

The System controls the room environment by engaging one of four modes: Cool, Dehumidify, Reheat, or Humidify. These modes may work differently depending on the options and equipment installed in your Modules.



Caution

The environmental controls are set when your System is installed. Changing settings described in this section after the System has been commissioned may result in improper operation.

How the modes work

Cool. When the cool mode uses a Chilled Water coil, the output is determined by the difference between the setpoint and the measured air temperature (control temperature) of each of the Modules in the System (if more than one Module is present). The control temperature can be the average return sensor value, the average remote sensor value, or the maximum remote sensor value, depending on the System settings (**Path: Main > Setup > System > System Setup > System Config > Sensor Setup**).



See “Sensor setup” on page 9 to choose the source of the temperature value the Module uses to calculate demand.

The Proportional plus Integral plus Derivative (PID) control loop calculates the output as demand increases and opens the valve controlling the flow of coolant into the coil. The PID adjusts the output as required to maintain the temperature at the setpoint.



See “PID controls” on page 24 for a description of the PID controls and instructions on tuning the fluid coil PID loop.

Reheat (Electric SCR and Modulating Hot Water). The SCR (silicon-controlled rectifier) electric reheat function is controlled by the reheat PID controller. The PID controller adjusts the output as required to maintain the temperature at the setpoint.



See “PID controls” on page 24 for a description of the PID controls and instructions on tuning the reheat PID loop.

Reheat (Hot Gas, Steam, Hot Water On/Off). The output of the hot gas, steam, and hot water on/off reheat options is determined by the difference between the setpoint and control temperature of the Module. When the control temperature at the Module reaches the setpoint minus the deadband, the reheat mode activates until the control temperature rises to the setpoint.



See “Deadbands” on page 23 for acceptable reheat deadband values.

Dehumidify. Dehumidify mode is controlled by the dehumidify PID controller. The PID controller adjusts the output as required to maintain the temperature at the setpoint.



See “PID controls” on page 24 for a description of the PID controls and instructions on tuning the dehumidify PID loop.

Humidify. The steam cylinder humidifier output is controlled by the humidify proportional controller. When the control humidity drops below the humidify setpoint, the humidifier output increases as the control humidity drops until the output reaches 100%.



See “Humidification sensitivity” on page 26 for a description of the Humidification sensitivity band.

Setpoints

Path: Main > Control Environment > Setpoints

| | |
|------------|---------|
| Cool : | 72.4°F |
| Reheat : | 68.5°F |
| Dehumid : | 53.2%RH |
| Humidify : | 48.4%RH |

Setpoints are the target values that each mode maintains in the room. The default setpoints are appropriate for most precision cooling applications.

The setpoint for each mode must be within the following ranges:

- Cool: 61.8–90.0° F (16.5 to 32.2° C)
- Reheat: 60.0–88.2° F (15.6 to 31.2° C)
- Dehumidify: 30–80% Relative Humidity
- Humidify: 30–80% Relative Humidity



If a mode is disabled and you change the setpoint, the display warns you that the mode is disabled. See “Modes” on page 23 to enable or disable operating modes.



You cannot overlap setpoints. If you overlap setpoints, the display warns you and resets the setpoints.

Note

The **Cool** setpoint must be 1.8° F (1° C) above the **Reheat** setpoint, if reheat is installed in the Module. The **Dehumid** setpoint must be 1% RH above the **Humidify** setpoint, if a humidifier is installed.

Deadbands

Path: Main > Control Environment > Deadbands

| | |
|-----------|---------|
| Cool: | 08.2°C |
| Reheat: | 06.4°C |
| Dehumid: | 10.0%RH |
| Humidify: | 08.2%RH |

The deadband is the sensitivity range for a setpoint. It is the value above or below the setpoint at which the mode outputs at full capacity. Acceptable deadband ranges include:

- Cool 0.5–10.0° F (0.28–5.6° C)
- Reheat 0.5–10.0° F (0.28–5.6° C)
- Dehumidify 1–10% RH
- Humidify 1–10% RH

Modes

Path: Main > Control Environment > Modes

| | |
|-----------|----------|
| Cool: | Enabled |
| Reheat: | Disabled |
| Dehumid: | Enabled |
| Humidify: | Enabled |

Enable and disable the modes of operation. The four modes are:

- Cool
- Reheat
- Dehumidify
- Humidify

Modes can be enabled or disabled only by using the service password.

Essential functions

Path: Main > Control Environment > Essential Functions

| | |
|-----------|------------|
| Cool: | Essential |
| Reheat: | Nonessent. |
| Dehumid: | Nonessent. |
| Humidify: | Nonessent. |

Designate each mode as either essential or nonessential. The modes marked as nonessential are disabled when an alarm or event occurs that requires all nonessential operations to be stopped (nonessential lockout).



See the table in “Input contacts” on page 14 to set up nonessential lockout events that occur when an input contact becomes active.

PID controls

Path: Main > Setup > System # > System Config > PID Controls

The Proportional plus Integral plus Derivative (PID) loop is used to control the output of the cool, reheat, and dehumidify modes.

```
01of03: Cool
Mode: Prop+Int+Der
P: 2 %/°
I: 5 %/°*min ↓
```

```
D: 2 %/°/min ↑
```

Choose which mode or actuator PID loop to tune, using the **01of03:** [Mode/Actuator name] setting.

Mode. Choose the multipliers to use in the PID algorithm. You can omit the derivative or the integral and derivative multipliers in the algorithm.

P. The proportional multiplier (gain) for this mode or actuator. The proportional multiplier adjusts for the difference (error) between the measurement (temperature or humidity) and the setpoint. The proportional multiplier is expressed in percent of output per unit error.

I. The integral multiplier (reset rate) for this mode or actuator. The integral multiplier adjusts for error measurement, and the amount of time that the error has existed. The integral multiplier adds to or subtracts from the output in small increments to correct for the offset error caused by the proportional contribution. It is expressed in percent of output for each minute and unit of error (error multiplied by minutes).

D. The derivative multiplier (derivative) for this mode or actuator. The derivative multiplier adjusts the output for rapid changes in the error, correcting for the rate of change of the error over time. It is expressed in percent of output for each unit of error per minute (error divided by minutes).

How to tune the PIDs

A qualified service technician must tune the PID loops to optimize the performance of each mode. The units shown are for temperature. In the dehumidify loop, the units are in percent relative humidity (%RH).



The PID loops must be tuned after the equipment in the room is installed and running. The loops should be tuned periodically to account for changes in the room load.

1. Select the PID loop to tune.
2. Adjust the integral and derivative constants to zero, and the proportional constant to twenty.
3. Set the temperature (cool or reheat) setpoint value and start the System.
4. When the temperature reaches a stable value, increase the proportional constant by 10. If the temperature does not respond to this change, adjust the setpoint.
5. Repeat step 4 until the temperature value starts to oscillate and the peak amplitude of the oscillations is constant.
6. Note the time, in minutes, between the peaks of the oscillations. This is the Ultimate Period, P_U .
7. Note the value of the proportional constant. This is the Ultimate Gain, G_U .
8. Compute the PID constants using the table below. Select the type of control from the rows of the table, and use the equations in the columns to compute the values for each constant.

| Control Method | Proportional | Integral | Derivative |
|----------------|--------------|--------------------|---------------------|
| P | $0.5 * G_U$ | – | – |
| P + I | $0.45 * G_U$ | $0.54 * G_U / P_U$ | – |
| P + I + D | $0.6 * G_U$ | $1.2 * G_U / P_U$ | $0.075 * G_U * P_U$ |

9. Set each constant according to these calculations.

You may need to further tune the PID loops in the following ways to account for changes in the room load:

| Loop Behavior | PID Tuning Correction |
|--|---|
| Slow response to temperature/humidity changes | Decrease the proportional multiplier or increase the derivative multiplier. |
| Over-cooling/Under-cooling after changes in the room load or changes in setpoint | Increase the derivative or the proportional multipliers. |
| Environmental temperature/humidity never reaches the setpoint | Increase the integral setting. |
| Over-cooling/Under-cooling on constant room load | Decrease the integral multiplier. |

Humidification sensitivity

Path: Main > Setup > System # > System Config > Humid. Sensitivity

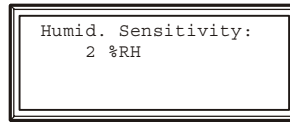

Humid. Sensitivity. The humidifier sensitivity band is the percentage of relative humidity below the humidify setpoint at which the humidifier operates at full output.

Set Up Alarms

Set alarms to alert you to abnormal temperatures or humidity levels and the number of hours certain components have been in operation. Alarms will also alert you to malfunctions; however, malfunction alarms are not user-definable.



See “Respond to Alarms” on page 39 to correct these conditions.



Note

Preset alarm-threshold default values are applicable for most precision air conditioning applications.

Temperature alarms

Path: Main > Setup > System # > Alarms > Temp Thrshlds

Temperature Thrshlds. Set the low- and high-temperature alarms for the air at each of the following locations. When the air temperature at the sensor is outside the range defined by the thresholds, an alarm will occur.

- | | |
|-------------|--|
| Sply | Temperature thresholds for the air blown into the room (supply). |
| Env | Thresholds for the air at the sensors measuring the room temperature, either the return or the remote sensors, depending on your settings. |

Humidity alarms

Path: Main > Setup > System # > Alarms > Humidity Thresholds

Humidity Thresholds. Set the low- and high-humidity alarms for the air at each of the following locations. When the relative humidity of the air at the sensor is outside the range defined by the thresholds, an alarm will occur.

- | | |
|------------|---|
| Env | Thresholds for the air at the sensors measuring the room humidity, either the return or the remote sensors, depending on your settings. |
|------------|---|

Maint intervals

Path: Main > Setup > System # > Alarms > Maint Intervals

The System records the number of hours each of the eight components in each Module has operated. Set the maintenance interval for each type of component in the Modules of your System. Every time the run hours for a component in a Module elapse this number of hours, an alarm will occur. Move the selector arrow next to the component name (top line of the screen), and press the ENTER key to scroll through each of the eight components.

Component name. Scroll through the components to view the maintenance intervals:

- Blower 1
- Blower 2
- Heater
- Humidifier
- Variable Frequency Drive 1 (VFD 1)
- Variable Frequency Drive 2 (VFD 2)

Alarm. Set the number of operating hours (in 100-hour increments) at which an alarm will occur to remind you of maintenance milestones.

Alarm delays

Path: Main > Setup > System # > Alarms > Alarm Delays

The alarm delay is the period between start-up and the enabling of alarms. The delay allows the modes (Cool, Reheat, Dehumidify, and Humidify) to take effect before alarms occur.

Temperature Delay. Set the temperature alarm delay. The maximum delay is 999 seconds (16 minutes, 39 seconds).

Humidity Delay. Set the humidity alarm delay. The maximum delay is 999 seconds (16 minutes, 39 seconds).

Coil fluid thresholds

Path: Main > Setup > System # > Alarms > Coil Fluid Thrshlds

The coil fluid coolant temperature thresholds set a range for temperatures at the coolant inlet (Water or Glycol) of the fluid coil (if equipped). An alarm occurs if the coolant temperatures move outside of this range.

Low Threshold. Set the coolant temperature at which a low temperature alarm will occur.

High Threshold. Set the coolant temperature at which a high temperature alarm will occur.

Set Up Group

Up to four NetworkAIR Systems can be connected to form a redundant Group. Joining Systems together to form a Group provides the following:

- Redundancy
- A way for other Systems in the Group to assist with the room load
- Demand fighting prevention (one System cooling while another reheats)
- System run time balancing
- Setpoint sharing among Systems
- Alarm sharing among Systems



Note

Group settings are copied to each System in the Group.

Group config

Path: Main > Setup > Group > Group Config

The **Group Config** settings define the options to use in the redundant Group.

Systems. Set the number of Systems connected together to form this Group. Setting the number of Systems to 1 disables the Group functions.

Setpoint Share. Enable or disable setpoint sharing among the Systems of this Group. When setpoint sharing is enabled, changes to the cool or reheat setpoint on any System in the Group are copied to all of the other Systems.



Note

The humidify and dehumidify setpoints are always shared.

Idle Blwr Spd. Set the behavior of the blowers for Systems that are in the idle, backup, or failed states. Systems that are not active (idle, backup, or failed) should maintain blower operation in raised floor installations to maintain static pressure and to keep cool air flowing to your data center equipment rather than up through an idle NetworkAIR FM System.

Dmnd Fighting. When enabled, reheat is prohibited for all Systems in the Group, when any System in the Group has a cooling demand. This prevents Systems from working against each other.

Grp Fire Alarm. Share fire alarms among the Systems in this Group. If the **Group Fire Alarm** setting is **On**, then all Systems in the Group will shut down if a fire alarm occurs in one System. If the **Group Fire Alarm** setting is **Off**, the alarms will still be shared with the other Systems, but they will not shut down.

Grp Smoke Alrm. Share smoke alarms among the Systems in this Group. If the **Group Smoke Alarm** setting is **On**, all Systems in the Group will shut down if a smoke alarm occurs in one System.

Comm Loss Failover. Decide if the Group considers a System in the **Comm Lost** state to be failed.

- **Off** — The Group will assume that the System is still operating normally.
- **On** — A backup System will be moved to the online state.



If **Runtime Balancing** is enabled, **Comm Loss Failover** must be **On**. Otherwise inadvertent System shutdowns may occur. This warning applies to firmware versions before 6.0.18.

Name. Set the name of this Group. The Group name also appears in the Network Management Card interfaces.

Group settings

Path: Main > Setup > Group > Group Settings

The **Group Settings** define the load-sharing and System role-assignment functions of the Group.

Load Share. Enable or disable load-sharing requests for each mode. If load-sharing is disabled, Systems cannot send requests for assistance to the Group.

Load Share Thrshlds. Set the load-sharing thresholds for each mode. If the environmental temperature or humidity is outside the range determined by the setpoint and threshold, the System will generate a load-sharing request. Acceptable ranges for each mode are:

| Mode | Range | Share if |
|------------|-------------------------|---|
| Cool | 0.0–20.0°F (0.0–11.1°C) | Temperature > Setpoint _{Cool} + Threshold _{Cool} |
| Reheat | 0.0–20.0°F (0.0–11.1°C) | Temperature < Setpoint _{Reheat} – Threshold _{Reheat} |
| Dehumidify | 0.0–20.0% RH | Humidity > Setpoint _{Dehumidify} + Threshold _{Dehumidify} |
| Humidify | 0.0–20.0% RH | Humidity < Setpoint _{Humidify} – Threshold _{Humidify} |

Sys Role Assignment. The System Role Assignment settings depend on the **Run-time Bal** setting.

- If **Run-time Bal** is set to **On**, each System is rotated between a primary and backup role in order to spread the run hours among all of the Systems in the Group. Rotation occurs after 72 hours of operation.
 - **# Primary:** Set the number of Systems to be designated as primary. The remaining Systems in the Group will assume the backup role.
- If **Run-time Bal** is set to **Off**, you must designate the role of each System in the Group. The System will retain this role until you change the setting.
 - **Sys# Role:** Set the role for each System. Backup Systems only operate in the event of a failure or load-sharing request (if enabled).



If **Runtime Balancing** is enabled, then **Comm Loss Failover** must be **On**. Otherwise inadvertent System shutdowns may occur. This warning applies to firmware versions before 6.0.18.

System failure events

Path: Main > Setup > Group > Group Settings > Sy Failure Events



Note

The **System Failure Events** must be configured at each System in the Group. Unlike other Group settings, the System Failure Events list is not copied to each System in the Group.

Configure the list of **System Failure Events**. If a System failure event occurs, the System in which it occurs transitions to the failed state, and a backup System is engaged if available.

Event. Scroll through the list of possible failure events. The first line indicates whether the event is System-level or Module-level, and the second line indicates the event text.

State. Set each event to **Enabled** or **Disabled**. If an enabled event occurs in a System, that System transitions to the failed state and stops running, unless there is no backup System available to come online.

Set Up the Display

Set display settings, including the time and date, temperature units, passwords, and time-out settings. You can also reset settings to their default values and download new firmware.

Password & Time-out

Path: Main > Setup > System > Display > Password & Time-out



Note

The default user password is **APC** (uppercase). See “Password entry” on page 4 for instructions on how to enter the password.

Change passwords. Set the passwords necessary to change System settings.

1. Move the selector arrow next to the **Change Password** option, and press the **ENTER** key.
2. Select the password to change (either **Service** or **User**).
3. Enter your current password.
4. On the **Change Password** screen, enter a new password (up to 8 characters).
5. Press the **ENTER** key to confirm the change.



Note

If you do not want settings to be protected by a password, enter a space character for the password.

Password and menu time-out. Set the time-out period during which settings can be changed after the password is entered. If no key is pressed during this period, password entry will be required and the display interface will return to the scrolling status screens.

Invalidate password. Use the **Invalidate NOW** option to override the password time-out delay and require password entry immediately.

Date and time

Path: Main > Setup > System # > Display > Date/Time

Set the date. Enter the day, month, and year, and press the **ENTER** key. The date is displayed on some status screens and is also used in the alarm/event log to date-stamp events.

Set the time. Enter the correct time, and press the **ENTER** key. The time is displayed on some status screens and is also used in the alarm/event log to time-stamp events.

Temperature and pressure units

Path: Main > Setup > System # > Display > Temp/Pressure Units

Temperature units. Set the units of measure for temperature readings and settings to either Fahrenheit (° F) or Celsius (° C).

Pressure units. Set the units of measure for pressure readings and settings to either English (psig) or metric (kPa).

Adjust display

Path: Main > Setup > System # > Display > Display Adjust

Set the LCD contrast. Adjust the visibility of the screen text. Lower numbered settings provide darker text; higher numbers provide lighter text. Settings range from 0–7.

Key click. Enable or disable a beep sound every time a key is pressed on the display interface.

How to update the firmware

Path: Main > Setup > System # > Display > Update Firmware

To update the controller firmware:

1. Go to www.apc.com/tools/download/ and check for the most recent version of the firmware.
2. If a newer version is available, download it to a location that can be accessed in step 4.



Stop the System before updating the firmware. For instructions, see “Stop the System” on page 5.

3. Set up the serial connection:
 - a. Connect an available serial port of your computer to the DB-9 serial port on the right side of the electrical panel (connector J2), using the supplied serial cable (APC Part Number 940-0103). To extend the cable, use APC cable number 940-1000A with 940-0103.
 - b. Run a terminal emulation program, such as HyperTerminal[®].
 - c. Configure the following settings on the serial port you selected:

| | |
|---------------------|-------|
| Baud Rate | 19200 |
| Data Bits | 8 |
| Parity | None |
| Stop Bits | 1 |
| Flow Control | None |



Some terminal emulation programs require that you disconnect and then reconnect the terminal session for the new serial port settings to take effect.

4. On the display interface, Select **YES** from the **Update Firmware** menu. Use the path you selected in step 2.
5. In your terminal emulator, ensure that the connection is active (HyperTerminal will display a series of “C” characters) and send the file using the XMODEM protocol.
6. When the download is complete, the screen displays the new version.
7. Restart the System.

Reset to defaults

Path: Main > Setup > System # > Display > Reset to Defaults

Reset User Params. Return settings that can be modified with the user password to their factory default settings.

Reset Srvc Params. Return settings that can be modified with the service password to their factory default settings.

Reset Group Params. Return Group settings that can be modified with the service password to their factory default settings.

Reset Controller. Restart the Module. Turns off the Module and then restarts it for service purposes.



The Module will not cool for several minutes during the restart process. Only trained field service personnel should use this feature.

Product data

Path: Main > Setup > System # > Display > Product Data

The **Product Data** option provides three screens of user-defined data that make identifying information available at the display interface.

Options on the **Product Data** screens include:

- Product Name
- Product Location
- Product Contact



Enter the text for these options on the display interface in the same manner as you enter a password. See “Password entry” on page 4.

Set up Network Configuration

Configure the network settings for Network Management Card from the display interface. The management card allows for remote control and configuration of the NetworkAIR FM Precision Air Conditioner.

Network config

Path: Main > Setup > System # > Network Config

MAC Address. Displays the unique network identifier assigned to each Network Management Card at the factory.

Mode. Set the method by which the System's Network Management Card will acquire its network settings.

- **Manual** — Scroll down and enter the network settings for the System's Network Management Card.
- **BOOTP** — Set the card to obtain its network settings from a BOOTP server.
- **DHCP** — Set the card to obtain its network settings from a DHCP server.

IP. Set the IP address assigned to this System's Network Management Card (Manual mode only).

MSK. Set the subnet mask for this System's Network Management Card (Manual mode only).

GW. Set the default gateway for this System's Network Management Card (Manual mode only).

Accept Changes. You must select **Accept Changes** to save any modifications to the IP Address, subnet mask, or default gateway.

View Status Readings

The display interface has several options for viewing the status of the System, its Modules, and the environment being controlled. The status readings for Modules are available under the **Main Module** and **Expansion Module #** options, and status readings for the System are available under the **System Status** option or on the scrolling status screens.



Note

Only the Main Module of a System has a display interface. The temperature and humidity readings displayed on the scrolling status screens are an average of the readings from each of the Modules.

If the System is off, the readings are the values from the sensors of the Main Module.

Scrolling status screens

When the display interface is idle, it scrolls through nine screens of status information. Press the up or down arrow key to interrupt the automatic scrolling and view a specific status screen.



See “Scrolling status screens” on page 2.

Module status

Paths: Main > Status > Main Module

Main > Status > Expansion Module 1

The Module status screens contain information for each Module in a System.

Temp & Humidity. View temperature and humidity readings at the supply, return, and remote sensors for each Module. This screen has the same format as the Temp & Humidity scrolling status screen, but the values displayed are only for the selected Module.

Pressures. View the differential pressures at the coil and the filter for this Module.

Run hours. View the total time each of the eight components have been running.

- **Clear Total:** Reset the run hours for the displayed component to zero.
- **Reset Maint Alarms:** Clear the Maintenance alarm for the displayed component. The alarm will occur when the run hours reach the next maintenance interval.



To scroll through and clear the total hours, see “Maint intervals” on page 28.

About Module. View identifying information that is helpful when obtaining service:

- Manufacturer Name
- Model Number
- Date of Manufacture
- Serial Number
- Firmware Revision
- Hardware Revision

Humidifier Status. View the humidifier output, current drawn by the humidifier, and the conductivity of the water in the humidifier cylinder in this Module.

Water Temps. View the coil fluid inlet temperatures for the coolant and hot water supplies (if applicable).

Blower [#] Status. View the status of blower 1 and blower 2 and the variable frequency drives that control the blowers.

Compressor Status. View the status of the compressors (in compressor-equipped Modules only).

System status

Path: Main > Status > System #

The System status screens include information about the entire System.

Temp & Humidity. View the average temperature and humidity readings at the sensors in this System (same as the Temp & Humidity scrolling status screen).

Return Sensors View the average temperature and humidity at the return sensors for this System.

Remote Sensors View the minimum temperature, average temperature, average humidity, and maximum temperature for the remote sensor probes.

Demands. View the percentage of output required of a mode to maintain its setpoint in the room.

Cool/Dehumidify View the cool mode and dehumidify mode demands (%) and the actual output. The actual reading is combined for the cool and dehumidify modes. The actual reading for the mode with the largest demand is displayed.

Reheat Demand View the status (On/Off) of the reheat mode as well as its percentage of demanded output. The On/Off status for reheat is displayed only for Modules equipped with steam, hot water, or hot gas reheat.

Humidify Demand View the actual and demanded output for the humidify mode.

Group status

Path: Main > Status > Group

The Group Status screen includes information about the member Systems of the Group and their roles.

Group Status. View the assigned role and current state of each System in the Group

Group Run Hours. View the run hours for each System in the Group

Reset Local System Run Hours. Reset the run hours of the local System. To reset the run hours of the other Systems, you must repeat this step at each System's display interface or Network Management Card. The service password is required to perform this action.

View Event Log

The event log saves status information and a message each time a change in the System is detected. Alarms and events are recorded in the log. However, status events (informational) are displayed only on the active alarms screen.

View Log

Path: Main > View Log

New Events. The **New Events** option displays a log of events that have occurred since the last time the log was checked.

Entire Log. The event log keeps a record of all alarms and events. Each event log entry consists of four screens of information. The initial screen consists of the following:

- The name of the alarm
- Its index number in the log and the Module to which it applies
- The time and date the event occurred
- The name (description) of the event

Use the arrow keys to scroll through the list of events.

To view more details about the event press the ENTER key. Two more screens display the following:

- Supply temperature and humidity
- Return temperature and humidity
- Output code (for use during service calls)

To move from screen to screen, use the arrow keys.

Clear Log. Erase all events in the log. You must enter the service password to erase the log.

Respond to Alarms

When an alarm is triggered, the Main Module alerts you through the display by the following methods:

- Alarm beeper
- Major or Minor Alarm LED
- Active alarm screen
- Alarm/Event log

Major or minor alarm LEDs

When an alarm is triggered, the Check Log LED and either the Minor Alarm LED or the Major Alarm LED activates. The Major and Minor Alarm LEDs cannot be deactivated manually; the alarm condition must be cleared to deactivate them.

Control beeper

Path: Main > Respond to Alarms

An active alarm creates a beeping sound from the display. This sound continues until you view the **Respond to Alarms** menu.

Beeper. To disable the beeper for all future alarms, set the **Beeper** setting to **Disabled**.

Beeper Volume. Set the volume of the beeper and key-click to **high**, **medium**, or **low**.

View active alarms

Path: Main > Respond to Alarms > View Active Alarms

The Active Alarms screen also appears on the scrolling status screens. It provides the number of the alarm (e.g. 1 of 2), a description of the condition, and a time-stamp of when the alarm happened. Press the ENTER key to view details of the alarm, or press the arrow keys to view the rest of the list.



See “Entire Log” on page 38 for more information on the alarm/event details screens.

Clear active alarms

Path: Main > Respond to Alarms > Clear Active Alarms

Clears all active alarms. If the conditions that caused the alarm still exist, those conditions cause the alarm to be regenerated.

- **Clear System Alarms** — Clear active alarms that apply to the Modules in this System.
- **Clear Group Alarms** — Clear active alarms that apply to the Group.

Reset sys failure

Path: Main > Respond to Alarms > Reset Sys Failure

Reset a System after a failure event has occurred. If the condition that caused the failure still exists, the System will fail again. A System will not restart after a failure until this command is executed.



Note

A System must be reset only if it is part of a Group. Stand-alone Systems will not go into the failure state.

Alarm messages and suggested actions

| Displayed Alarm Message | Action Required |
|-------------------------------|---|
| Air Block Interlock Open | <ul style="list-style-type: none"> • Verify that the air block is in place. • Confirm that the wiring connections for the air block interlock are secure. |
| Air Filter Clogged | <ul style="list-style-type: none"> • Verify the condition of the return air filters, and replace them if required. • Check the pressure drop across the filters by reviewing the System status. • Ensure that the pressure-sensing tubing is properly connected to the sensor. • Verify that the ends of the pressure-sensing tubing are not blocked or placed incorrectly. • Verify that the correct filter is selected in the System Options menu (Path: Main > Setup > System > System Config > System Options). |
| Airflow Low | <ul style="list-style-type: none"> • Check the pressure drop across the filters, and replace the filters if necessary. • Check the pressure drop across the evaporator coil on the pressures screen of the display interface (Path: Main Menu > Status > [Module] > Pressures). The reading should be close to the recommended coil differential pressure drops indicated in the table “Coil Differential Pressure Values” on page 18. If the reading is too low based on Module size and options installed, adjust the blower speed. • Verify the proper operation of the Variable Frequency Drive (VFD) and blower motors. • Verify that the VFD overload alarm is not active. • Ensure that any field-installed dampers in the discharge duct are open. • Verify that the Mode Delay is not too short. If the Mode Delay is too short, the Airflow Low alarm occurs after start up and resolves itself after a few minutes. |
| Backup is Load Sharing | <ul style="list-style-type: none"> • A backup System is contributing to meet the room load. • No action required. The backup will return to idle when the demand falls. |
| Backup System Idle | <ul style="list-style-type: none"> • A primary System has come back online after a failover event. • No action required. |
| Backup System Online | <ul style="list-style-type: none"> • Indicates that a System failover has occurred. The backup System has come online due to another online System that either failed or was commanded off. A System Comm Loss is considered to be a System failure if the Comm Loss Failover configuration setting is Yes (the default setting). • Check the System’s event log to determine the cause of the System failure. |
| Blower 1 Requires Maintenance | <ul style="list-style-type: none"> • Verify operation of Blower 1 and perform preventive maintenance. • Reset the maintenance alarm for Blower 1 on the display interface. |
| Blower 2 Requires Maintenance | <ul style="list-style-type: none"> • Verify operation of Blower 2 and perform preventive maintenance. • Reset the maintenance alarm for Blower 2 on the display interface. |
| Condensate Pump Fail | <ul style="list-style-type: none"> • Verify that the condensate pump circuit breaker has not been tripped. • Ensure that the wiring between the float switch for the condensate pump and the controller is secure. • Confirm that the condensate removal lines are free of debris and are unobstructed. • Confirm the line voltage at the condensate pump. • Ensure that the condensate float switch is moving freely and does not bind. • Confirm that the condensate pump reservoir is clean and free of debris. • Replace the condensate pump. |

| Displayed Alarm Message | Action Required |
|--------------------------------|--|
| Cooling Coil Coolant Temp High | <ul style="list-style-type: none"> • Check the chilled water supply temperature. • Verify that the coil fluid coolant temperature high threshold is not set below the normal temperature of your chilled water supply. |
| Cooling Coil Coolant Temp Low | <ul style="list-style-type: none"> • Check the chilled water supply temperature. • Verify that the coil fluid coolant temperature low threshold is not set above the normal temperature of your chilled water supply. |
| Cooling Coil No Coolant Flow | <ul style="list-style-type: none"> • Verify the flow from the chilled water supply. • Verify that the chilled water supply isolation valve is open. • Check the operation of the flow switch. • Check the electrical connections to the flow switch. |
| Env Humidity High | <ul style="list-style-type: none"> • Verify that no supply air is fed directly into the return air stream. • Ensure that the alarm delay is not set too low. The delay should be long enough to allow the humidity in the room to stabilize after start-up. • Verify that the alarm threshold for the humidity of the environmental sensors (return or remote) is set above the humidify and dehumidify setpoints. • Check the capacity output of the humidifier and reduce it if required. • Ensure that there is a proper vapor barrier within the conditioned space. • Ensure that the dehumidify mode is enabled. • Verify that the Module is configured and equipped for the dehumidify mode. • Ensure that the dehumidify mode is not disabled because of an active customer input mapped to nonessential lockout. |
| Env Humidity Low | <ul style="list-style-type: none"> • Ensure that the alarm delay is not set too low. The delay should be long enough to allow the humidity in the room to stabilize after start-up. • Verify that the alarm threshold for the humidity of the environmental sensors (return or remote) is not above the humidify and dehumidify setpoints. • Ensure that there is a proper vapor barrier within the conditioned space. • Verify that the Module is configured and equipped for the humidify mode. • Ensure that the humidify mode is enabled. • Check the capacity output of the humidifier and increase it if required. • Ensure that the humidify mode is not disabled because of an active user-defined input mapped to nonessential lockout. |
| Env Temperature High | <ul style="list-style-type: none"> • Check whether the Module is cooling. Look for a temperature differential of 15–20 F ° (8–11 C °) between the supply and control (return or remote) temperatures. • Ensure that there is no concentrated heat source in the return air stream of the Module. • Ensure that the alarm delay is not set too low. The delay should be long enough to allow the room temperature to stabilize after start-up. • Verify that the temperature alarm threshold for the environmental (return or remote) sensors is above the cool and reheat setpoints. • Ensure that the cooling mode is enabled. • Ensure that the cooling mode is not disabled because of an active customer input mapped to nonessential lockout. |

| Displayed Alarm Message | Action Required |
|------------------------------|--|
| Env Temperature Low | <ul style="list-style-type: none"> • Verify that no supply air is fed directly back into the return air. • Ensure that the alarm delay is not set too low. The delay should be long enough to allow the room temperature to stabilize after start-up. • Verify that the temperature alarm threshold for the environmental (return or remote) sensors is below the cool and reheat setpoints. • Verify that the Module is configured and equipped for the reheat mode. • Ensure that the reheat mode is enabled (if your Module is equipped with reheat). • Ensure that the reheat mode is not disabled because of an active user-defined input mapped to nonessential lockout. |
| Fire Detected | <ul style="list-style-type: none"> • Follow the appropriate facility emergency protocol. NOTE: The purpose of the fire sensor is to warn you of possible equipment damage. It is NOT intended to provide a fire alarm system to protect the facility and the lives of its occupants. • Confirm that the wiring connections are secured to the wiring harness. • Verify the setting of the fire detector (fire stat). • Replace the fire detector (fire stat). |
| Fluid Coil Actuator Fail | <ul style="list-style-type: none"> • Verify that the connections between the actuator and the controller board are correct and securely tightened. • Confirm that the control voltage and signal voltage reach the actuator. • Ensure that the proper Module configuration is defined for this Module, especially that the coil configuration and the actuator type are correct. • Replace the Fluid Coil Actuator. |
| Group Configuration Invalid | <ul style="list-style-type: none"> • Check that the # Systems setting (Path: Main > Setup > Group > Group Config) agrees with the actual number of Systems connected to the Group. Increase this setting to match the number of connected Systems. |
| Group Configuration Conflict | <ul style="list-style-type: none"> • Verify the Group configuration settings (Path: Main > Setup > Group) are correct. The Group detected one or more Systems in the Group to have different Group configuration settings and changed that System's settings. |
| Group Fatal Fire Shutdown | <ul style="list-style-type: none"> • Check the Systems in this Group for fire alarms. The Group Fatal Fire Shutdown occurs only when the Group Fire Alarm configuration setting (Path: Main > Setup > Group Config > Grp Fire Alarm) is On. While the fire alarm is active, the Group will remain shut down. |
| Group Fatal Smoke Shutdown | <ul style="list-style-type: none"> • Check the Systems in this Group for smoke alarms. The Group Fatal Smoke Shutdown occurs only when the Group Smoke Alarm configuration setting (Path: Main > Setup > Group Config > Grp Smoke Alarm) is On. While the smoke alarm is active, the Group will remain shut down. |
| Heater Requires Maintenance | <ul style="list-style-type: none"> • Verify the operation of the heater and perform preventive maintenance. • Reset the maintenance alarm on the display interface for the heater. |
| Humidifier Current High | <ul style="list-style-type: none"> • Verify that the proper voltage is applied to the humidifier cylinder. • Confirm that the line voltage connections to the cylinder are secure and correct. • Ensure that the humidifier water supply has not been conditioned. Conditioning can increase the water conductivity. • Check the humidifier cylinder for mineral buildup that bridges the electrodes. • Check the fill and drain valves for leaks. |

| Displayed Alarm Message | Action Required |
|---------------------------------------|---|
| Humidifier Cylinder Depleted | <ul style="list-style-type: none"> • Replace the disposable cylinder. • Clean the reusable humidifier cylinder (optional). |
| Humidifier Cylinder Full when Off | <ul style="list-style-type: none"> • Check the humidifier drain valve for clogging. • Check the operation of the humidifier drain solenoid. |
| Humidifier Drain Malfunction | <ul style="list-style-type: none"> • Ensure that the drain is free of any debris. • Verify the operation of the drain solenoid valve. |
| Humidifier Excessive Foam | <ul style="list-style-type: none"> • Verify that the humidifier water supply is not using conditioned water and that the water does not contain contaminants. • Check the humidifier water supply hose for dirt and contaminants. • Check the steam supply hose for kinks that may cause back-pressure. |
| Humidifier Excessive Output Reduction | <ul style="list-style-type: none"> • Reduce the humidifier sensitivity setting on the display interface (Path: Main > Setup > System # > System Config > Humid. Sensitivity) if necessary. |
| Humidifier Fault Tolerance Exceeded | <ul style="list-style-type: none"> • The humidifier has experienced three faults within one-half hour. • Reset the humidifier from the display interface (Path: Main > Setup > Module > [Module in which the alarm occurred] > Module Control > Reset Humidifier). |
| Humidifier Internal Memory Error | <ul style="list-style-type: none"> • Check the controller connections to the humidifier for electrical discharge. |
| Humidifier No Power | <ul style="list-style-type: none"> • Verify that the circuit breaker for the humidifier has not been tripped. • Confirm that the line voltage connections to the cylinder are secure and correct. |
| Humidifier Requires Maintenance | <ul style="list-style-type: none"> • Verify the operation of the humidifier and perform preventive maintenance. • Reset the maintenance alarm on the display interface for the humidifier. |
| Humidifier Water Conductivity High | <ul style="list-style-type: none"> • Verify that the proper voltage is being applied to the humidifier cylinder. • Confirm that the line voltage connections to the cylinder are secure and correct. • Ensure that the water supply to the humidifier has not been conditioned. Conditioned water can increase water conductivity. |
| Humidifier Water Level Low | <ul style="list-style-type: none"> • Verify that the humidifier water supply is open and flowing to the humidifier water connection. • Confirm that the inlet water strainer on the humidifier fill solenoid is clear and free of debris. • Ensure that the water pressure is at least at 30 psig (206 kPa). • Verify the operation of the fill solenoid valve. |
| Module Powered Up | <ul style="list-style-type: none"> • The Module has successfully started. |
| No Backup Systems Available | <ul style="list-style-type: none"> • Check the number of Systems designated for the backup role. • Check that the backup Systems are not in the failed or Comm Lost states, or Off. |
| Primary Sensors Failed | <ul style="list-style-type: none"> • Verify that there is a proper CAN connection between sensors and the user interface box. • Replace the sensor assembly. |

| Displayed Alarm Message | Action Required |
|--------------------------|--|
| Remote Sensor Removed | <ul style="list-style-type: none"> • Check the CAN bus connection to the remote sensors. • Disregard if you removed the remote sensor. |
| Remote Sensor Added | <ul style="list-style-type: none"> • Check the CAN bus connection to the remote sensors. • Disregard if you added the remote sensor. |
| Replace Steam Cylinder | <ul style="list-style-type: none"> • Replace the steam cylinder. • Clean the steam cylinder (if your System is equipped with re-usable humidifier cylinders). |
| Return Sensor Fail | <ul style="list-style-type: none"> • Verify that there is a proper CAN connection between the sensors and the user interface box. • Replace the sensor assembly. |
| Secondary Sensors Failed | <ul style="list-style-type: none"> • Verify that there is a proper CAN connection between sensors and the user interface box. • Replace the sensor assembly. |
| Smoke Detected | <ul style="list-style-type: none"> • Follow the appropriate facility emergency protocol. NOTE: The purpose of the smoke sensor is to warn you of possible equipment damage. It is NOT intended to provide a smoke alarm system to protect the facility and the lives of its occupants. • Confirm the wiring connections are secure to the wiring harness. • Ensure smoke head and sub-base are properly attached. • Ensure that there is not dirt or dust on the smoke head. Use pressurized air to clean the smoke head chamber. • Replace the smoke detector. |
| Supply Sensor Fail | <ul style="list-style-type: none"> • Verify that there is a proper CAN connection between sensors and the user interface box. • Replace the sensor assembly. |
| Supply Temperature High | <ul style="list-style-type: none"> • Ensure that the alarm delay is not set too low. The delay should be long enough to allow the Module to control the temperature after start-up. • Verify that the supply air temperature alarm threshold is set above the cool and reheat setpoints. • Verify that there is proper airflow through the Module (check the pressure drop across the evaporator coil). • Ensure that the cool mode is enabled. • Ensure that the cool mode is not disabled because of an active user-defined input mapped to nonessential lockout. |
| Supply Temperature Low | <ul style="list-style-type: none"> • Ensure that the alarm delay is not set too low. The delay should be long enough to allow the Module to control the temperature after start-up. • Verify that the Module is configured and equipped for the reheat mode. • Ensure that the supply air temperature alarm threshold is set below the reheat and cool setpoints. • Ensure that the reheat mode is enabled. • Ensure that the reheat mode is not disabled because of an active user-defined input mapped to nonessential lockout. • Verify that there is proper airflow through the Module (check the pressure drop across the evaporator coil). |

| Displayed Alarm Message | Action Required |
|------------------------------|---|
| System Comm Lost | <ul style="list-style-type: none"> • Check that the System is receiving power. • Check the external CAN bus connections. • Check the System ID DIP switch settings of every Main Module in the Group. Each Main Module must have a unique address. See the <i>Installation Manual</i> for the correct DIP switch settings. |
| System Failure | <ul style="list-style-type: none"> • After correcting the cause of the system failure, perform a Reset System Failure command (Path: Main > Respond to Alarms > Reset Sys Failure). |
| System Fire Detected | <ul style="list-style-type: none"> • Follow the appropriate facility emergency protocol. NOTE: The purpose of the fire sensor is to warn you of possible equipment damage. It is NOT intended to provide a fire alarm system to protect the facility and the lives of its occupants. • See “Fire Detected” on page 43 for the appropriate alarm actions. |
| System Off | <ul style="list-style-type: none"> • Turn on power to the System (Path: Main > On/Off). |
| System Smoke Detected | <ul style="list-style-type: none"> • Check the Modules in the System for Smoke Detected alarms. • Follow the appropriate facility emergency protocol. NOTE: The purpose of the smoke sensor is to warn you of possible equipment damage. It is NOT intended to provide a smoke alarm system to protect the facility and the lives of its occupants. • See “Smoke Detected” on page 45 for the appropriate alarm actions. |
| VFD # 1 Requires Maintenance | <ul style="list-style-type: none"> • Verify the operation of VFD # 1 and perform preventive maintenance. • Reset the maintenance alarm for VFD #1 on the display interface. |
| VFD # 2 Requires Maintenance | <ul style="list-style-type: none"> • Verify the operation of VFD # 2 and perform preventive maintenance. • Reset the maintenance alarm for VFD #2 on the display interface. |
| Water Detected | <ul style="list-style-type: none"> • Determine the source of the leak, and repair it. • Confirm that the water detector is not short-circuited to metal and ensure that there is not debris or soldering on the rope component of the water detector that could be providing false detection. • Ensure that the water detector is properly mounted and secured to the bottom of the Module or the floor. • Confirm that the wiring connections are secure. • Replace the water detector. |

Network Management Card

Quick Configuration

The NetworkAIR FM Precision Air Conditioner is shipped with a Network Management Card that provides for the management of the Air conditioner over your network. You must set up the Network Management Card in order to control the NetworkAIR FM Precision Air Conditioner through a Web browser.



Disregard the procedures in this section if you have APC InfraStruXure Manager as part of your system. See the InfraStruXure Manager's documentation for more information.

Overview

You must configure the following TCP/IP settings before the Network Management Card can operate on a network:

- IP address of the Network Management Card
- Subnet mask
- Default gateway



Note

If a default gateway is unavailable, use the IP address of a computer that is located on the same subnet as the Network Management Card and that is usually running. The Network Management Card uses the default gateway to test the network when traffic is very light.



See also

See “Watchdog Features” in the “Introduction” of the NetworkAIR FM *User's Guide* for more information about the watchdog role of the default gateway.

TCP/IP configuration methods

Use one of the following methods to define the basic TCP/IP settings needed by the Network Management Card:

- APC Device IP Configuration Wizard (See “APC Device IP Configuration Wizard” on page 48.)
- BOOTP or DHCP server (See “BOOTP & DHCP configuration” on page 48.)
- Local computer (See “Local access to the control console” on page 51.)
- Networked computer (See “Remote access to the control console” on page 52.)

APC Device IP Configuration Wizard

You can use the APC Device IP Configuration Wizard at a Windows NT[®] 4.0, Windows 2000, Windows 2003, or Windows XP computer to configure a Network Management Card.



See also

To configure one or more Network Management Cards from a user configuration file, see the *User's Guide* on the NetworkAIR FM Precision Air Conditioner *Utility* CD.

Insert the NetworkAIR FM Precision Air Conditioner *Utility* CD into a computer on your network.

1. Launch the Device IP Configuration Wizard, when prompted, or, if prompted to restart the computer, access the Wizard from the **Start** menu after the computer has restarted.
2. Wait for the Wizard to discover the unconfigured Network Management Card, then follow the on-screen instructions.



Note

If you leave the **Start a Web browser when finished** option enabled, you can use **apc** for both the user name and password to access the Network Management Card through your browser.

BOOTP & DHCP configuration

The **Boot Mode** Setting, a TCP/IP option in the Network Management Card's **Network** menu, identifies how the TCP/IP settings will be defined. The possible settings are **Manual**, **DHCP only**, **BOOTP only**, and **DHCP & BOOTP** (the default setting).



The **DHCP & BOOTP** setting assumes that a properly configured DHCP or BOOTP server is available to provide TCP/IP settings to Network Management Cards. If these servers are unavailable, see "APC Device IP Configuration Wizard" on this page, "Local access to the control console" on page 51, or "Remote access to the control console" on page 52 to configure the needed TCP/IP settings.

With **Boot Mode** set to **DHCP & BOOTP**, the Network Management Card attempts to discover a properly configured server. It first searches for a BOOTP server, then a DHCP server, and repeats this pattern until it discovers a BOOTP or DHCP server.



See "BOOTP" on page 49 or "DHCP" on page 50.

BOOTP. You can use an RFC951-compliant BOOTP server to configure the TCP/IP settings for the Network Management Card.



The **DHCP & BOOTP** setting assumes that a properly configured DHCP or BOOTP server is available to provide TCP/IP settings to Network Management Cards.

1. Enter the Network Management Card's MAC and IP addresses, the subnet mask and default gateway settings, and an optional bootup file name in the BOOTPTAB file of the BOOTP server.



Note

For the MAC address, look on the nameplate of the NetworkAIR FM Precision Air Conditioner.

2. When the Network Management Card reboots, the BOOTP server provides it with the TCP/IP settings.
 - If you specified a bootup file name, the Network Management Card attempts to transfer that file from the BOOTP server using TFTP or FTP. The Network Management Card assumes all settings specified in the bootup file.
 - If you did not specify a bootup file name, the Network Management Card can be configured remotely by using the control console or the Web interface. User name and password are both **apc**, by default.



See also

To create the bootup file, see your BOOTP server documentation.

DHCP. You can use a RFC2131/RFC2132-compliant DHCP server to configure the TCP/IP settings for the Network Management Card.



See also

This section briefly summarizes the Network Management Card communication with a DHCP server. For more detail about how a DHCP server is used to configure the network settings for a Network Management Card, see “DHCP Configuration” in the NetworkAIR FM Precision Air Conditioner *Users’ Guide*.

3. A Network Management Card sends out a DHCP request that uses the following to identify itself:
 - A Vendor Class Identifier (APC by default)
 - A Client Identifier (by default, the Network Management Card’s MAC address value)
 - A User Class Identifier (by default, the identification of the Network Management Card’s application firmware)
4. A properly configured DHCP server responds with a DHCP offer that includes all of the settings that the Network Management Card needs for network communication. The DHCP offer also includes the Vendor Specific Information option (DHCP option 43). By default, the Network Management Card will ignore DHCP offers that do not encapsulate the APC cookie in the Vendor Specific Information option using the following hexadecimal format:

```
Option 43 = 01 04 31 41 50 43
```

where

- the first byte (01) is the code
- the second byte (04) is the length
- the remaining bytes (31 41 50 43) are the APC cookie



See your DHCP server documentation to add code to the Vendor Specific Information option. To disable the APC cookie requirement, see “Local access to the control console” on page 51.

To change the control console’s **DHCP Cookie Is** setting, use the **Advanced** option in the TCP/IP menu. See “Remote access to the control console” on page 52.

Local access to the control console

You can use a local computer that connects to the Network Management Card through the serial port on the control board to access the control console. Whenever possible access the control panel through a network connection.



The procedure requires the front door and right side (low voltage) of the electrical panel of the NetworkAIR FM Precision Air Conditioner to be open, which creates an electrical hazard.

1. Select a serial port at the local computer, and disable any service that uses that port.
2. Use the configuration cable (APC part number 940-0103) to connect the selected port to the serial port (J2) on the controller board. The controller board is in the right compartment of the electrical panel.



Do not touch components on the electrical panel, other than the serial port.

3. Run a terminal program (such as HyperTerminal) and configure the selected port for 2400 bps, 8 data bits, no parity, 1 stop bit, and no flow control, and save the changes.
4. Press ENTER to display the **User Name** prompt.
5. Use **apc** for the user name and password.
6. See “Control console” on page 53 to finish the configuration.

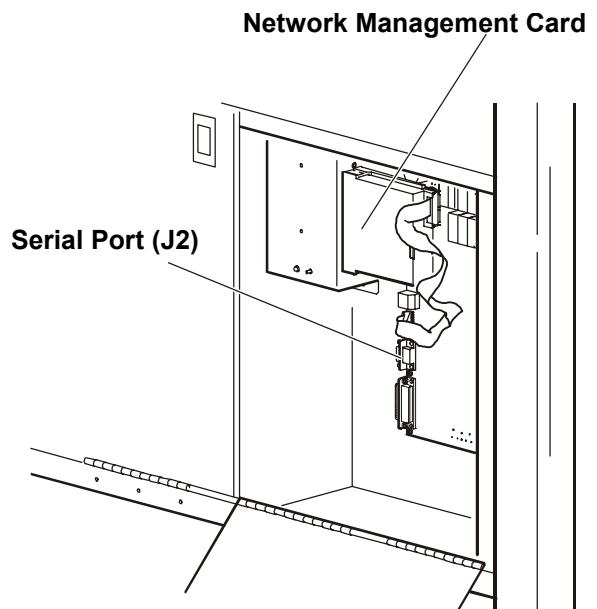

Remote access to the control console

From any computer on the same subnet as the Network Management Card, you can use ARP and Ping to assign an IP address to a Network Management Card, and then use Telnet to access that Network Management Card's control console and configure the needed TCP/IP settings.



Note

After a Network Management Card has its IP address configured, you can use Telnet, without first using ARP and Ping, to access that Network Management Card.

1. Use ARP to define an IP address for the Network Management Card, and use the Network Management Card's MAC address in the ARP command. For example, to define an IP address of 156.205.14.141 for a Network Management Card that has a MAC address of 00 c0 b7 63 9f 67, use one of the following commands:

– Windows command format:

```
arp -s 156.205.14.141 00-c0-b7-63-9f-67
```

– LINUX command format:

```
arp -s 156.205.14.141 00:c0:b7:63:9f:67
```



Note

For the MAC address, look on the nameplate of the NetworkAIR FM Precision Air Conditioner.

2. Use Ping with a size of 113 bytes to assign the IP address defined by the ARP command. For the IP address defined in step 1, use one of the following Ping commands:

– Windows command format:

```
ping 156.205.14.141 -l 113
```

– LINUX command format:

```
ping 156.205.14.141 -s 113
```

3. Use Telnet to access the Network Management Card at its newly assigned IP address. For example:

```
telnet 156.205.14.141
```

4. Use **apc** for both user name and password.
5. See “Control console” on page 53 to finish the configuration.

Control console

After you log on at the control console, as described in “Local access to the control console” on page 51 or “Remote access to the control console” on page 52:

1. Choose **Network** from the **Control Console** menu.
2. Choose **TCP/IP** from the **Network** menu.
3. If you are not using a BOOTP or DHCP server to configure the TCP/IP settings, select the **Boot Mode** menu. Select **Manual boot mode**, and then press ESC to return to the **TCP/IP** menu. (Changes will take effect when you log out.)
4. Set the **System IP**, **Subnet Mask**, and **Default Gateway** address values.
5. Press CTRL-C to exit to the **Control Console** menu.
6. Log out (option 4 in the **Control Console** menu).



Note

If you disconnected a cable during the procedure described in “Local access to the control console” on page 51, reconnect that cable and restart the associated service.

How to Access a Configured Module

Overview

After the Network Management Card is running on your network, you can use the interfaces summarized in this section to access the NetworkAIR FM Precision Air Conditioner.



See also

For more information on the interfaces, see the *User's Guide* on the NetworkAIR FM Precision Air Conditioner *Utility CD*.

Web interface

As your browser, you can use Microsoft® Internet Explorer 5.0 (and higher) or Netscape® 4.0.8 (and higher, except Netscape 6.x) to access the Management Card through its Web interface. Other commonly available browsers also may work but have not been fully tested by APC.

To use the Web browser to configure NetworkAIR FM options or to view the event log, you can use either of the following:

- The HTTP protocol (enabled by default) provides authentication by user name and password but no encryption.
- The more secure HTTPS protocol provides extra security through Secure Sockets Layer (SSL) and encrypts user names, passwords, and data being transmitted. It also provides authentication of Network Management Cards by means of digital certificates.

To access the Web interface and configure the security of your device on the network:

1. Address the Network Management Card by its IP address or DNS name (if configured).
2. Enter the user name and password (by default, **apc** and **apc** for an Administrator, or **device** and **apc** for a Device Manager).
3. Select and configure the type of security you want. (This option is available only for Administrators.)



See also

See “Security” in the *User's Guide* for information on choosing and setting up your network security. Use the **Web/SSL** option of the **Network** menu to enable or disable the HTTP or HTTPS protocols.

Telnet/SSH

You can access the control console through Telnet or Secure SHell (SSH), depending on which is enabled. (An Administrator can enable these access methods through the **Telnet/SSH** option of the **Network** menu.) By default, Telnet is enabled. Enabling SSH automatically disables Telnet.

Telnet for basic access. Telnet provides the basic security of authentication by user name and password, but not the high-security benefits of encryption. To use Telnet to access an NetworkAIR FM Precision Air Conditioner's control console from any computer on the same subnet:

1. At a command prompt, use the following command line, and press ENTER:

```
telnet address
```

As *address*, use the NetworkAIR FM Precision Air Conditioner's IP address or DNS name (if configured).

2. Enter the user name and password (by default, **apc** and **apc** for an Administrator, or **device** and **apc** for a Device Manager).

SSH for high-security access. If you use the high security of SSL for the Web interface, use Secure SHell (SSH) for access to the control console. SSH encrypts user names, passwords and transmitted data.

The interface, user accounts, and user access rights are the same whether you access the control console through SSH or Telnet, but to use SSH, you must first configure SSH and have an SSH client program installed on your computer.



See also

See the *User's Guide* for more information on configuring and using SSH.

SNMP

After you add the PowerNet MIB to a standard SNMP MIB browser, you can use that browser for SNMP access to the Network Management Card. The default read community name is **public**; the default read/write community name is **private**.



Note

If you enable SSL and SSH for their high-security authentication and encryption, disable SNMP. Allowing SNMP access to the Network Management Card compromises the high security you implemented by choosing SSL and SSH. To disable SNMP, you must be an Administrator; use the **SNMP** option of the **Network** menu.

FTP/SCP

You can use FTP (enabled by default) or Secure CoPy (SCP) to transfer new firmware to the Network Management Card, or to access a copy of the NetworkAIR FM's event logs. SCP provides the higher security of encrypted data transmission and is enabled automatically when you enable SSH.



Note

If you enable SSL and SSH for their high-security authentication and encryption, disable FTP. Allowing file transfer to the NetworkAIR FM through FTP compromises the high security you implement by choosing SSL and SSH. To disable FTP, you must be an Administrator; use the **FTP Server** option of the **Network** menu.

To access the Network Management Card through FTP or SCP, the default user name and password are **apc** and **apc** for an Administrator, or **device** and **apc** for a Device Manager. In the command line, use the IP address of the unit.



See also

See the *User's Guide* to use FTP or SCP to transfer firmware files to or to retrieve log file from the Network Management Card.

How to Recover From a Lost Password

You can use a local computer, a computer that connects to the Network Management Card or other device through the serial port to access the control console.



Warning

The procedure requires the front door and right side (low voltage) of the electrical panel of the NetworkAIR FM Precision Air Conditioner to be open, which creates an electrical hazard.

1. Select a serial port at the local computer, and disable any service that uses that port.
2. Use the configuration cable (APC part number 940-0103) to connect the selected port to the serial port (J2) on the controller board. The controller board is in the right compartment of the electrical panel.



Electrical Hazard

Do not touch components on the electrical panel, other than the serial port.

3. Run a terminal program (such as HyperTerminal) and configure the selected port as follows:
 - 2400 bps
 - 8 data bits
 - no parity
 - 1 stop bit
 - no flow control
4. Press **ENTER**, repeatedly if necessary, to display the **User Name** prompt. If you are unable to display the **User Name** prompt, verify the following:
 - The serial port is not in use by another application.
 - The terminal settings are correct as specified in step 3.
 - The correct cable is being used as specified in step 2.
5. Press the **Reset** button on the faceplate of the Network Management Card. The Status LED will flash alternately orange and green. Press the **Reset** button a second time immediately while the LED is flashing to reset the user name and password to their defaults temporarily.
6. Press **ENTER** as many times as necessary to re-display the **User Name** prompt, then use the default, **apc**, for the user name and password. (If you take longer than 30 seconds to log on after the **User Name** prompt is re-displayed, you must repeat step 5 and log on again.)

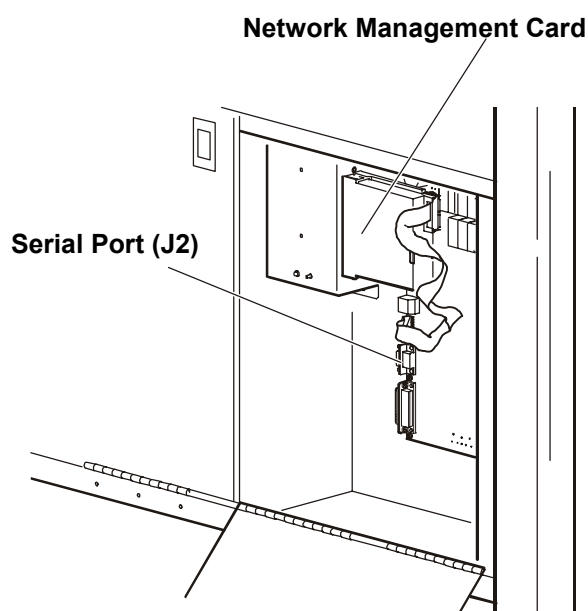

7. From the **Control Console** menu, select **System**, then **User Manager**.
8. Select **Administrator**, and change the **User Name** and **Password** settings, both of which are now defined as **apc**.
9. Press CTRL-C, log off, reconnect any serial cable you disconnected, restart any service you disabled, close all panels, and re-install doors.



Do not touch components on the electrical panel, other than the serial port.

How to Upgrade Firmware



See also

For a complete description on how to download a firmware upgrade for your Network Management Card and transfer it to the unit, see the *User's Guide* on the provided NetworkAIR FM Precision Air Conditioner *Utility CD*.

For you to be able to use FTP to upgrade a single Network Management Card over the network:

- The Network Management Card must be attached to the network.
- The FTP server must be enabled at the Network Management Card.
- The Network Management Card must have its TCP/IP settings (**System IP**, **Subnet Mask**, and **Default Gateway** addresses) configured.

To use FTP to upgrade the Network Management Card:

1. Open an MS-DOS command prompt window on a computer that is connected to the network. Go to the directory that contains the firmware upgrade files, and list the files. For the directory `C:\apc`, the commands would be those shown in **bold**:

```
C:\>cd\apc  
C:\apc>dir
```

Files listed for a NetworkAIR FM Precision Air Conditioner, for example, might be the following:

```
- apc_hw02_aos_260.bin  
- apc_hw02_nairfm_261.bin
```

2. Open an FTP client session:

```
C:\apc>ftp
```

3. Type `open` and the Network Management Card's IP address, and press `ENTER`. If the **Port** setting for **FTP Server** in the **Network** menu has changed from its default value of **21**, you must use the non-default value in the FTP command.
 - a. For some FTP clients, use a colon to add the port number to the end of the IP address.
 - b. For Windows FTP clients, separate the port number from the IP address by a space. For example, if the Network Management Card's **FTP Server Port** setting has been changed from its default of **21**, such as to **21000**, you would use the following command for a Windows FTP client transferring a file to a Network Management Card with an IP address of 150.250.6.10.

```
ftp> open 150.250.6.10 21000
```
4. Log on using the Administrator user name and password (**apc** is the default for both).

5. Upgrade the AOS. For example:

```
ftp> bin  
ftp> put apc_hw02_aos_260.bin
```

6. When FTP confirms the transfer, type `quit` to close the session.
7. Wait 20 seconds, and then repeat step 2 through step 5 for the application module. In step 5, use the application module file instead of the AOS module.

Maintenance

Monthly Preventive Maintenance

Photocopy and use the pages in this section during the maintenance procedures and save them for future reference.

Prepared by: _____

Model Number: _____

Serial Number: _____

Date: _____

Environment

- In what type of room is the Module located?

- Is the Module maintaining the temperature/humidity setpoint?

 - Temperature setpoint _____
 - Humidity setpoint _____
- Is there visible damage to the Module (dents, scratches)?

- Is there environmental damage (dirt, dust, debris, liquid stains) around the Module installation area?

- Record the room temperature and humidity near the return vent of the Module.
 - Temperature _____
 - Humidity _____
- Record last month's alarm history.

Cleanliness

- Check the condition of return air filters. Replace them if necessary.
- Check the condition of the drain pan and remove any accumulation of debris in the pan.

Mechanical

- Ensure that all components of the blower and its motor are moving freely, with no signs of binding or damages.
- Inspect the set-screws on fan blades and bushings to make sure that they are tight.
- Verify that the condensate line is flowing freely.
- Verify that the humidification system does not have leaks at the fill and drain valves and that these modes of operation are functional.
- Ensure that there are no kinks in the steam delivery system from the cylinder top to the steam distributor.
- Check for build-up in optional cleanable cylinders and clean them as required.
Cylinder size _____
- Replace disposable humidifier cylinders if necessary.
Cylinder size _____
- Verify the chilled water supply temperature.
Chilled water supply temperature _____

Electrical

- Inspect the electrical panel to ensure tight connections. Tighten any loose contact terminals, which can cause overheated connections.
- Confirm that the incoming main power is within 10% of the main power requirement listed on the Module's nameplate.
- Verify that the control voltage is within 10% of 24 V.

Quarterly Preventive Maintenance

Photocopy and use the pages in this section during the maintenance procedures, and save them for future reference.

Perform all the Monthly Preventive Maintenance items AND the items in this section.

Prepared by: _____

Model Number: _____

Serial Number: _____

Date: _____

Mechanical

- Check the water lines for leaks.
- Verify that the hardware of the blower and its motor are tight.

Electrical

- Record the amperages for the following components.

| Component | L1 | L2 | L3 | FLA |
|-------------------------|-----------|-----------|-----------|------------|
| Cooling Coil fan motors | | | | |
| Motor #1 | | | | |
| Motor #2 | | | | |
| Reheat | | | | |
| Humidifier | | | | |

Functional tests

- Verify the following modes of operation:
 - Full cooling
 - Full reheat
 - Humidification
 - Dehumidification

- Verify the operation of these actuators:
 - Chilled water
 - Hot water reheat (optional)

Semi-Annual Preventive Maintenance

Photocopy and use the pages in this section during the maintenance procedures and save them for future reference.

Perform all the Monthly/Quarterly Preventive Maintenance items AND the items below.

Prepared by: _____

Model Number: _____

Serial Number: _____

Date: _____

Cleanliness

- Ensure that the chilled water coil is clean.

Electrical

- Verify that the contactors and relays are operating correctly.
- Check the main power wiring for the following components:
 - Reheat elements
 - Evaporator motors
 - Humidifiers

Functional tests

- Verify the operation of the coil fluid (water regulating) valves:
Pressure (PSI) _____
- Check the operation of all System alarms.

Troubleshooting

Refrigeration

| Problem | Possible Cause | Corrective Action |
|-------------------------------------|---|--|
| Controls are erratic or inoperative | <ul style="list-style-type: none"> • Incorrect secondary voltage. • Remote shutdown input is cycling the Module on and off. | <ul style="list-style-type: none"> • Ensure that the control transformer secondary voltage is within +/- 10% of 24 VAC. • Check the event log for an entry in the log that indicates remote shutdown activity. |
| Evaporator motor fails to start | <ul style="list-style-type: none"> • Control circuit breaker is tripped. • Frequency Drive is in an alarm condition or has failed. | <ul style="list-style-type: none"> • Reset the control circuit breaker. • Check the event log for a VFD alarm entry. Replace the frequency drive. |
| Humidifier inoperative | <ul style="list-style-type: none"> • Humidifier circuit breaker tripped. • Water supply strainer may be clogged. • Improper water supplied to humidifier. • Nonessential lockout has been activated by a user-defined input with the equipment. | <ul style="list-style-type: none"> • Check for short circuit. Reset the circuit breaker. • Remove and clean the strainer. • For proper operation, the humidifier requires a regular water supply. Any treated water (demineralized, softened, or ionized water) will result in improper humidifier operation. • Review the event log to see if this alarm input has been activated. |
| Reheat elements inoperative | <ul style="list-style-type: none"> • Circuit breaker is open. • Nonessential lockout has been activated by a user-defined input with the equipment. | <ul style="list-style-type: none"> • Check for direct short circuits. Reset the circuit breaker. • Review the event log to see if this alarm input has been activated. |
| Airflow too low | <ul style="list-style-type: none"> • External static pressure is too high. • The pressure drop across the chilled water coil is below the recommended value. • Cooling setpoint is too low. | <ul style="list-style-type: none"> • Try to compensate by increasing the blower speed to match recommended coil pressure drops. • Raise the Module to the minimum height or add duct transitions to direct the air across the floor. • Check the chilled water coil pressure drop through the display interface. Pressure should match recommended pressure drops indicated on the chart based on Module size. If the pressure drop is below the recommended settings, increase the blower speed until the pressure drop matches the recommended setting. See “Calibrate airflow > manually” on page 18. • Verify that the cooling setpoint is not below 68° F (20° C). |
| Airflow too high | <ul style="list-style-type: none"> • External static pressure may be too low. | <ul style="list-style-type: none"> • Check the evaporator coil pressure drop through the display interface. Pressure should match the recommended pressure drops indicated on the chart based on Module size. If the pressure drop is above the recommended settings, decrease the blower speed until the pressure drop matches the recommended setting. See “Calibrate airflow > manually” on page 18. |

| Problem | Possible Cause | Corrective Action |
|--|---|---|
| Temperature control not precise enough | <ul style="list-style-type: none"> • Cooling and reheat settings are not close enough. • Reheat PID loop is not properly tuned. • SCR controller is not working. • The mode of operation is turned off. • Nonessential lockout has been activated by a user-defined input with the equipment. • Return air temperature is reading incorrectly. | <ul style="list-style-type: none"> • Check setpoints for cooling and heating as well as deadbands. • Tune the PID loop for accurate reheat operation. • Confirm the operation of the SCR controller. • Check to verify that the proper modes of operation, cooling, and reheat are activated. A Module must have specific options installed to allow all modes of operation to be active. • Review event log to see if this alarm input has been activated. • Return air is not coming from the common space and may be influenced by a close heat source or a discharge air duct affecting return air temperatures. Try to eliminate the hot or cold air stream or relocate the sensor for better room temperature readings. |
| Humidification control is not precise enough | <ul style="list-style-type: none"> • Check the setpoints for humidification and dehumidification. • Humidifier may not be operating correctly. • The mode of operation is turned off. • Non-essential mode input has been activated by customer interface with equipment. • The room is not properly sealed internally to maintain vapor pressure in the controlled space. | <ul style="list-style-type: none"> • Verify that the setpoints are not too far apart. Typical setpoint between humidification and dehumidification is 10%. • Verify humidification operation. Ensure that there are no humidifier alarms that could impede the humidification process. • Ensure that the proper modes of operation, humidification and dehumidification, are activated. A Module must have specific options installed to allow all modes of operation to be active. • Review the event log to see if this alarm input has been activated. • The room must have an adequate vapor barrier installed to maintain humidification and dehumidification setpoints. The vapor barrier is inadequate if humidity in the controlled space changes based on influences from the surrounding air outside the controlled space. |

Electrical

| Problem | Possible Cause | Corrective Action |
|---|--|---|
| Humidifier inoperative | <ul style="list-style-type: none"> • Water supply is not on. • Electrical connections are loose. • Humidifier fuse is open. • Relative humidity is above the setpoint. | <ul style="list-style-type: none"> • Turn on the supply. • Tighten all electrical connections. • Check for short circuits, and replace blown fuses. • No action needed. |
| Reheat elements inoperative | <ul style="list-style-type: none"> • Overheat switch is actuated. • A fuse is open. • The thermostat is set too low. • The thermal fuse in the heater is open. | <ul style="list-style-type: none"> • Reset and check for operation. • Check for short circuit. • Adjust thermostat to required temperature. • Replace thermal fuse. |
| Water carryover | <ul style="list-style-type: none"> • Insufficient air quantity over the cooling coil. • Dirty coil. • Excessive air flow. • Blocked drain pan or trap. | <ul style="list-style-type: none"> • Check for correct airflow and clean filters. • Clean the coil. • Reduce CFM to specifications. • Clean the drain pan and trap. |
| Module is receiving power, but will not operate | <ul style="list-style-type: none"> • Remote shutdown enabled. | <ul style="list-style-type: none"> • Disable remote shutdown. |

Warranty

Limited Product Warranty for APC Products

The limited warranty provided by American Power Conversion Corporation (“APC”) in this Statement of Limited Factory Warranty applies only to Products you purchase for your commercial or industrial use in the ordinary course of your business.

LIMITED FACTORY WARRANTY

APC product covered

APC NetworkAIR FM Precision Air Conditioning Unit

Terms of warranty

APC warrants that the Product shall be free from defects in materials and workmanship for a period of one (1) year from the date of start-up when APC authorized service personnel performed the start-up of the Product, or a maximum of 18 months from the date of Product shipment from APC, when APC authorized service personnel have not performed the start-up of the Product (“Warranty Period”). In the event that the Product fails to meet the foregoing warranty, APC shall repair or replace any defective parts, such repair or replacement to be without charge for on-site labor and travel if APC authorized personnel have conducted start-up of the Product. An APC Start-Up Service must be performed/completed by APC authorized service personnel or replacement of defective parts only will be covered. APC shall have no liability and no obligation to repair the installed Product if non-authorized personnel performed the start-up and such start-up caused the Product to be defective. Any parts furnished under this warranty may be new or factory-remanufactured. **This warranty does not cover** circuit breaker resetting, loss of refrigerant, consumables, or preventative maintenance items. **Repair or replacement of a defective product or part thereof does not extend the original warranty period.**

Non-transferable Warranty extends to first purchaser for use

This Warranty is extended to the first person, firm, association or corporation (herein referred to by “You” or “Your”) for whom the APC Product specified herein has been purchased. This Warranty is not transferable or assignable without the prior written permission of APC.

Assignment of warranties

APC will assign to you any warranties which are made by manufacturers and suppliers of components of the APC Product and which are assignable. Any such warranties are assigned “AS IS” and APC makes **no representations** as to the effectiveness or extent of such warranties, assumes NO RESPONSIBILITY for any matters which may be warranted by such manufacturers or suppliers and extends no coverage under this Warranty to such components.

Drawings, descriptions

APC warrants for the Warranty Period and on the terms of the Warranty set forth herein that the APC Product will substantially conform to the descriptions contained in the APC Official Published Specifications or any of the drawings certified and agreed to by an authorized APC representative, if applicable thereto (“Specifications”). It is understood that the Specifications are **not warranties of performance** and **not warranties of fitness for a particular purpose**.

Warranty claims procedure

To obtain service under Warranty, contact APC Customer Support at (800) 800-4272. You will need the model number of the Product, the serial number, and the date purchased. A technician will ask you to describe the problem. If it is determined that the Product will need to be returned to APC you must obtain a returned material authorization (RMA) number from APC Customer Support. Products that must be returned must have the RMA number marked on the outside of the package, and be returned with transportation charges prepaid. If it is determined by APC Customer Support that on-site repair of the Product is allowed, APC will arrange to have APC authorized service personnel dispatched to the Product location to repair or replace the Product at the discretion of APC.

Exclusions

APC shall not be liable under the Warranty if its testing and examination discloses that the alleged defect in the product does not exist or was caused by your or any third person’s misuse, negligence, improper installation or testing, unauthorized attempts to repair or modify, or any other cause beyond the range of the intended use, or by accident, fire, lightning or other hazard.

THERE ARE NO WARRANTIES, EXPRESSED OR IMPLIED, BY OPERATION OF LAW OR OTHERWISE, OF PRODUCTS SOLD, SERVICED OR FURNISHED UNDER THIS AGREEMENT OR IN CONNECTION HEREWITH. APC DISCLAIMS ALL IMPLIED WARRANTIES OF MERCHANTABILITY, SATISFACTION AND FITNESS FOR A PARTICULAR PURPOSE. THE APC EXPRESS WARRANTIES WILL NOT BE ENLARGED, DIMINISHED, OR AFFECTED BY AND NO OBLIGATION OR LIABILITY WILL ARISE OUT OF APC RENDERING TECHNICAL OR OTHER ADVICE OR

SERVICE IN CONNECTION WITH THE PRODUCTS. THE FOREGOING WARRANTIES AND REMEDIES ARE EXCLUSIVE AND IN LIEU OF ALL OTHER WARRANTIES AND REMEDIES. THE WARRANTIES SET FORTH ABOVE, CONSTITUTE SOLE LIABILITY OF APC AND YOUR EXCLUSIVE REMEDY FOR ANY BREACH OF SUCH WARRANTIES. THE WARRANTIES EXTEND ONLY TO YOU AND ARE NOT EXTENDED TO ANY THIRD PARTIES.

IN NO EVENT SHALL APC, ITS OFFICERS, DIRECTORS, AFFILIATES OR EMPLOYEES BE LIABLE FOR ANY FORM OF INDIRECT, SPECIAL, CONSEQUENTIAL OR PUNITIVE DAMAGES ARISING OUT OF THE USE, SERVICE OR INSTALLATION OF THE PRODUCTS, WHETHER SUCH DAMAGES ARISE IN CONTRACT OR TORT, IRRESPECTIVE OF FAULT, NEGLIGENCE OR STRICT LIABILITY OR WHETHER APC HAS BEEN ADVISED IN ADVANCE OF THE POSSIBILITY OF SUCH DAMAGE.

Warranty Procedures

Labor

- APC will support labor costs if a quality issue is found during start-up that is determined to be caused by workmanship or a factory defect.
- The mechanical contractor who is performing the repairs must call APC technical services to obtain a repair authorization number before any work is started.
- The mechanical contractor must provide detailed information, (photos, start-up sheets) to APC technical services before any repairs are started.
- If any repairs are performed without prior authorization, APC will not pay for any labor cost.
- APC will not support claims for any of the following:
 - Truck rental
 - Travel time
 - Rental on recovery machine and cylinders
 - Gas mileage
 - Solder, flux, sil-phos, silver solder, and silver solder flux.
- APC will pay for \$2.50 per pound for refrigerant.

To obtain a repair authorization number for a NetworkAIR product, call APC NetworkAIR technical services between 8:00 A.M. and 5:00 P.M. Eastern time, Monday through Friday:

- Phone: (1)(888)695-6500 (USA and Canada, toll free)
- Fax: (1)(401)788-2691

Parts

- APC warrants the parts of their systems for 1 year from the date of start-up or 18 months from the shipping date of the system. This warranty covers only the cost of the part and not the labor for installation.
- Warranty parts requests need to have specific unit information (serial number, model number, job number) to allow proper identification and processing of the warranty part transaction.
- A purchase order may be required to issue any warranty part. An invoice will be sent once a parts order is filled and shipped to the field. You have 30 days to return a part to APC. After 30 days, the warranty invoice will be outstanding and payment of the invoice will be expected in full.

- Return authorization documentation will be sent with any replacement part. This documentation must be sent back with the defective part to APC for proper identification of the warranty return. Mark the warranty return number on the outside of the package.
- After the part has been received at APC, APC will determine the status of the credit based on an examination of the returned part. Parts that are damaged from: lack of maintenance, mis-application, improper installation, shipping damage, and acts of man/nature will not be covered under the parts warranty.
- For any warranty parts request received before 1:00 PM EST, the part will be shipped Same Day Standard Ground delivery. Any costs associated with Next Day or Airfreight will be the responsibility of the party requesting the part.
- Shipping costs for warranty parts are the responsibility of the sender.

To request warranty parts, contact APC NetworkAIR division technical services.

Phone: (1)(888)695-6500 (USA and Canada, toll-free)

Fax: (1)(401)788-2691

Index

Symbols

- # Modules in sys, 7
- # PCIOMs, 7
- ? key, 1

A

- Actuator types
 - coil fluid actuator, 12
 - condenser valve actuator, 12
- Actuators
 - condenser valve, 12
- Address, 9
- Adjust blower
 - blower speed, 18–19
 - coil differential pressure, 18
 - coil differential pressure, 19
- Adjust the screen, 33
- Adjust volume, 39
- Alarm beeper
 - silencing, 39
- Alarm detectors
 - fire detector, 17
 - smoke detector, 17
 - water detector, 17
- Alarm map descriptions, 15
- Alarm setup
 - humidity, 27
 - maintenance intervals, 28
 - temperature, 27
- Alarms
 - delay, 28
 - Economizer coolant temperature thresholds, 28
 - humidifier fault tolerance exceeded, 19–20
 - humidity, 27
 - maintenance intervals, 28
 - MultiCool coolant temperature thresholds, 28
 - temperature, 27
 - VFD fault tolerance exceeded, 19
- Arrow keys, 1

B

- Baud rate, 9
- Beeper
 - disable key click, 33
 - silencing, 39
- Blower spd setting, 18–19
- Building management system
 - Main Module address, 9
 - RS-485 bus, 9

C

- Check log LED, 1
- Cndsr Vlv actuator setting, 12
- Cndsr Vlv Dly setting, 8
- Cndsr Vlv setting, 12
- Coil cfg setting, 6
- Coil diff. pres setting, 18–19
- Coil differential pressure table
 - suggested values, 18
- Coil fluid actuator setting, 12
- Coil fluid setting, 12
- Coil fluid temp activation
 - deadband, 13
 - threshold, 13
- Comm loss shtdown dly setting, 9
- Comp min OFF setting, 8
- Comp min ON setting, 8
- Compressor Delays, 8–9
- Conds pump setting, 17
- Configure module, 17
- Contacts
 - input contacts, 14
 - output relays, 15
- Continue arrow, 3
- Contrast
 - adjust LCD, 33
- Control Environment
 - PID Controls, 24
- Control environment
 - deadband, 23
 - essential functions, 23
 - setpoints, 22

Cool

- deadband, 23
- setpoint, 22
- Cool/dehum demand status, 37

D

- D (PID), 24
- Date
 - set the current date, 32
- Deadband, 23
 - dehumidify, 23
 - humidify, 23
- Dehumidify
 - capacity setting, 7
 - deadband, 23
 - setpoint, 22
- Delays
 - input contact delay, 14
 - temperature alarm, 28
- Demands
 - cool/dehumidify, 37
 - humidify, 37
 - reheat, 37
- Demands status (system), 37
- Derivative, 24
- Discharge pressure, 36
- Display
 - date, 32
 - pressure units, 33
 - product contact, 34
 - product location, 34
 - product name, 34
 - reset service defaults, 34
 - reset to user defaults, 34
 - temperature units, 33
 - time, 32
- Display interface
 - adjust contrast, 33
 - changing the password, 32
- Controls, 1
 - LCD screen, 1
 - LEDs, 1
- Download firmware, 33

E

- Economizer
 - low temperature coolant alarm threshold, 28
- Enter key, 1
- Entire log option, 38
- Environmental control
 - deadbands, 23
 - essential functions, 23
 - PID controls, 24
 - setpoints, 22
- ESC key, 1
- Event log
 - entire log, 38
 - new events, 38
- Events
 - output relay maps, 15
 - relay map actions, 15

F

- Fire setting, 17
- Firmware
 - updating, 33
- Flow switch setting, 12

H

- Heat of rejection, 7
- Heater setting, 17
- Help key, 1
- Humid. setting, 17
- Humidification sensitivity band, 26
- Humidifier
 - mode setting, 20
 - reset, 19–20
 - type, 17
- Humidifier status (module), 37
- Humidifier, set up
 - humidifier mode, 20
- Humidify, 22
 - deadband, 23
 - setpoint, 22
- Humidify demand status, 37

I

- I (PID), 24
- Input arrow, 3

Input contacts

- alarm map, 15
 - delay, 14
 - name, 14
 - nonessential lockout, 23
 - normal state, 14
- ## Input/output
- input contacts, 14
 - output relays, 15
- ## Inputs
- alarm map descriptions, 15
- ## Integral, 24
- ## Intrstg Dly setting, 9
- ## Invalidate password, 32

K

- Key click
 - enable or disable, 33

L

- LCD Screen, 1
- Lockout, 23

M

- Maintenance, 61
- Major Alarm LED, 1, 39
- Minor Alarm LED, 1, 39
- Mode (PID), 24
- Mode Dly setting, 9
- Modes
 - Economizer and MultiCool cool, 21
 - Humidify, 22
 - MultiCool Dehumidify, 22
 - Reheat, 21
 - Reheat hot gas, steam, hot water on/off, 21
- Module rotation setting, 8
- Module status
 - humidifier status, 37
 - run hours, 36
 - temp & humidity, 36
 - water temperatures, 37
- MultiCool
 - low temperature coolant alarm threshold, 28

N

- New events option, 38
- Nonessential lockout
 - assigning modes, 23

O

- Output cap. setting, 17
- Output relays
 - map, 15
 - map actions, 15
 - normal state, 16

P

- P (PID), 24
- Parity, 9
- Password
 - changing, 32
 - invalidate, 32
 - Service, 4
 - time-out, 32
 - User, 4
- PCIOMs, 7
- PID controls, 24
 - D (derivative), 24
 - gain setting, 24
 - humidifier gain, 26
 - I (integral), 24
 - mode, 24
 - P (proportional), 24
 - reset rate, 24
 - tuning, 25
- Pressure
 - Discharge, 36
 - Suction, 36
 - units displayed, 33
- Product data
 - contact, 34
 - location, 34
 - name, 34
- Programmable customer input/output modules, 7
- Proportional, 24

R

- Reheat, 21
 - deadband, 23
 - setpoint, 22
 - Reheat demand status, 37
 - Rej method setting, 7
 - Relays, 15
 - Reset humidifier, 19–20
 - Reset Rate, 24
 - Reset variable frequency drive
 - Reset VFD, 19
 - Resolving alarm conditions, 41
 - Respond to alarms
 - alarm messages, 41
 - resolve alarm conditions, 41
 - silence the beeper, 39
 - view active alarms, 39
 - Run hours status (module), 36
- ## S
- Screen icons
 - continue arrow, 3
 - input arrow, 3
 - selector arrow, 3
 - Scrolling status screens, 2
 - Selector arrow, 3
 - Service defaults, resetting, 34
 - Service Password, 4
 - Setpoints, 22
 - cool, 22
 - dehumidify, 22
 - humidify, 22
 - reheat, 22
 - Smoke setting, 17
 - Start-up Dly setting, 9
 - Status
 - demands (system), 37
 - humidifier status (module), 37
 - run hours (module), 36
 - scrolling status screens, 2
 - temp & humidity (module), 36
 - temp & humidity (system), 37
 - water temps (module), 37
 - Status LED, 1
 - Stop bits, 9
 - Suction pressure, 36

- System delays
 - communication loss shutdown delay, 9
 - compressor minimum off, 8
 - compressor minimum on, 8
 - condenser fluid valve delay, 8
 - interstage, 9
 - mode, 9
 - start-up, 9
- System options
 - coil configuration, 6
 - dehumidify capacity, 7
 - heat of rejection method, 7
 - module rotation, 8
 - number of Modules in this system, 7
 - number of PCIOMs, 7
 - voltage, 6
- System status, 37
 - demands, 37
 - temp & humidity, 37

T

- Temp & humidity status (module), 36
- Temp & humidity status (system), 37
- Temperature
 - units displayed, 33
- Thresholds
 - humidity, 27
 - temperature, 27
- Time
 - set the time, 32
- Time-out password, 32
- Troubleshooting, 66
- Tuning PIDs, 25

U

- Update firmware, 33
- User defaults, resetting, 34
- User Password, 4

V

- Valve types
 - Coil Fluid valve setting, 12
 - condenser fluid valve type, 12
 - flow switch type, 12
- VFD
 - reset, 19
- View active alarms option, 39
- Voltage setting, 6
- Volume of beeper, 39

W

- Water setting, 17
- Water temps status (module), 37



APC Worldwide Customer Support

Customer support for this or any other APC product is available at no charge in any of the following ways:

- Visit the APC Web site to access documents in the APC Knowledge Base and to submit customer support requests.
 - **www.apc.com** (Corporate Headquarters)
Connect to localized APC Web sites for specific countries, each of which provides customer support information.
 - **www.apc.com/support/**
Global support searching APC Knowledge Base and using e-support.
- Contact an APC Customer Support center by telephone or e-mail.
 - Regional centers:

| | |
|--|--------------------------------|
| Direct InfraStruXure Customer Support Line | (1)(877)537-0607 (toll free) |
| APC headquarters U.S., Canada | (1)(800)800-4272 (toll free) |
| Latin America | (1)(401)789-5735 (USA) |
| Europe, Middle East, Africa | (353)(91)702000 (Ireland) |
| Japan | (0) 35434-2021 |
| Australia, New Zealand, South Pacific area | (61) (2) 9955 9366 (Australia) |

- Local, country-specific centers: go to **www.apc.com/support/contact** for contact information.

Contact the APC representative or other distributor from whom you purchased your APC product for information on how to obtain local customer support.

To obtain a repair authorization number for a NetworkAIR product, call APC NetworkAIR technical services between 8:00 A.M. and 5:00 P.M. Eastern time, Monday through Friday:

- Phone: (1)(888)695-6500 (USA and Canada only, toll free)
- Fax: (1)(401)788-2691

Entire contents copyright © 2004 American Power Conversion. All rights reserved. Reproduction in whole or in part without permission is prohibited. APC, the APC logo, NetworkAIR, NetShelter, and InfraStruXure are trademarks of American Power Conversion Corporation and may be registered in some jurisdictions. All other trademarks, product names, and corporate names are the property of their respective owners and are used for informational purposes only.



990-2220-001



12/2004