



Main

Range of product	OsiSense XU
Series name	General purpose single mode
Electronic sensor type	Photo-electric sensor
Sensor name	XUX
Sensor design	Compact 92 x 71
Detection system	Diffuse with background suppression
Material	Plastic
Type of output signal	Discrete
Supply circuit type	DC
Wiring technique	3-wire
Discrete output type	PNP or NPN
Discrete output function	1 NO or 1 NC programmable
Electrical connection	1 male connector M12, 4 pins
Product specific application	Long sensing distance with high accuracy
Emission	Infrared
[Sn] nominal sensing distance	2 m

Complementary

Enclosure material	PC
Lens material	PMMA
Output type	Solid state
Status LED	1 LED (green) for supply on 1 LED (red) for instability 1 LED (yellow) for output state
[Us] rated supply voltage	12...24 V DC with reverse polarity protection
Supply voltage limits	10...36 V DC
Switching capacity in mA	<= 100 mA (overload and short-circuit protection)
Switching frequency	150 Hz
Voltage drop	<= 1.5 V (closed state)
Current consumption	35 mA (no-load)
Delay first up	< 200 ms
Delay response	< 3.5 ms

Delay recovery	< 2.5 ms
Product weight	0.2 kg

Environment

Product certifications	CE CSA UL
Ambient air temperature for operation	-25...55 °C
Ambient air temperature for storage	-40...70 °C
Vibration resistance	7 gn (f = 10...55 Hz) conforming to IEC 60068-2-6
Shock resistance	10 gn (duration = 11 ms) conforming to IEC 60068-2-27
IP degree of protection	IP30 (with cover open) conforming to IEC 60529 IP65 (double insulation) conforming to IEC 60529 IP67 (double insulation) conforming to IEC 60529

Offer Sustainability

RoHS (date code: YYWW)	Compliant - since 1136 - Schneider Electric declaration of conformity Schneider Electric declaration of conformity
REACH	Reference not containing SVHC above the threshold Reference not containing SVHC above the threshold

Contractual warranty

Warranty period	18 months
-----------------	-----------

Dimensions

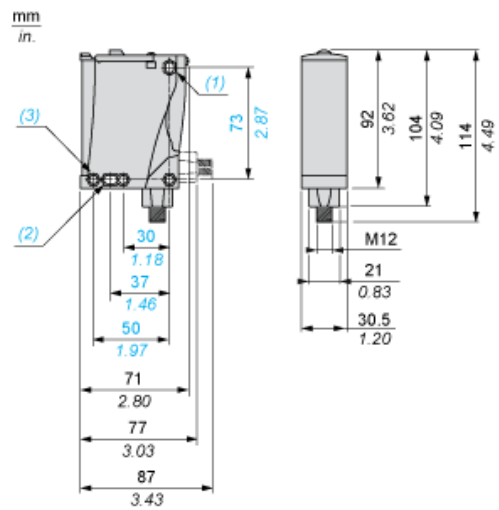

- (1) Elongated hole \varnothing 5.5 x 7
- (2) Elongated hole \varnothing 5.5 x 9
- (3) \varnothing 5.5 hole

Mounting and Clearance

Possible Orientation of Elbowed Connector (Rear View)

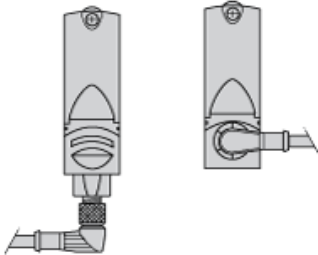

Wiring Schemes

M12 Connector

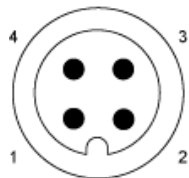

PNP/NPN DC

M12		Terminals		
1		1		+
3		2		-
4		3		Output
2		4		Alarm inactive

Detection Curves

Variation of Usable Sensing Distance S_u

Teach Mode at Minimum

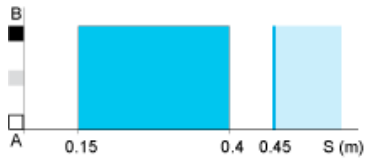

Teach Mode at Maximum

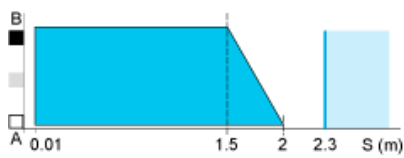

- (1) Black
- (2) Grey
- (3) White
- (4) Sensing range
- (5) Non sensing zone (matt surfaces)

A-B : Object reflection coefficient

- (1) Black 6%
- (2) Grey 18%
- (3) White 90%
- (4) Sensing range
- (5) Non sensing zone (matt surfaces)

Detection Curves

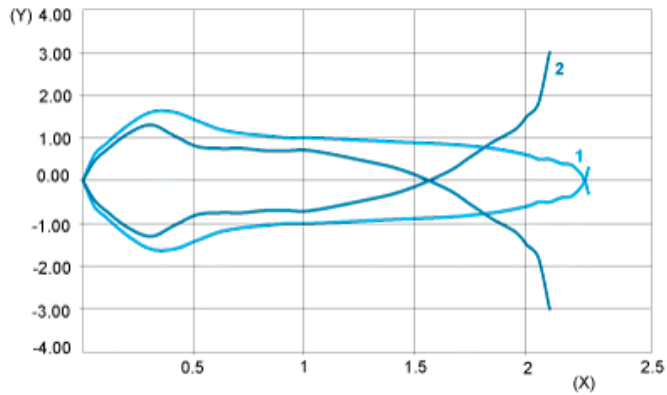

- 1 : White 90%
- 2 : Grey 18%
- (Y) Detection lobe (cm)
- (X) Object distance (m)

Object 10 x 10 cm

Relative Difference in Sensing Distances According to Object Colour

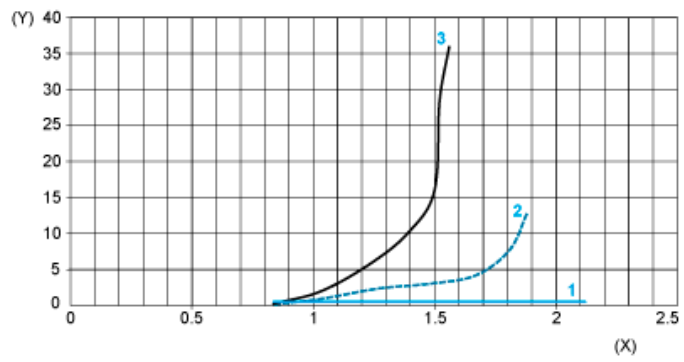

- 1 : White 90%
 - 2 : Grey 18%
 - 3 : Black 6%
 - (Y) Relative error (%)
 - (X) Object distance (m)
- Object 10 x 10 cm