



## Main

Range of product	OsiSense XS
Series name	General purpose
Sensor type	Inductive proximity sensor
Device application	-
Sensor name	XS4
Sensor design	Cylindrical M12
Size	35 mm
Body type	Fixed
Detector flush mounting acceptance	Non flush mountable
Material	Plastic
Type of output signal	Discrete
Wiring technique	3-wire
[Sn] nominal sensing distance	4 mm
Discrete output function	1 NO
Output circuit type	DC
Discrete output type	PNP
Electrical connection	Cable
Cable length	5 m
[Us] rated supply voltage	12...24 V DC with reverse polarity protection
Switching capacity in mA	<= 200 mA DC with overload and short-circuit protection
IP degree of protection	IP68 double insulation conforming to IEC 60529

## Complementary

Thread type	M12 x 1
Detection face	Frontal
Front material	PPS
Enclosure material	PPS

Operating zone	0...3.2 mm
Differential travel	1...15% of Sr
Cable composition	3 x 0.34 mm <sup>2</sup>
Wire insulation material	PvR
Status LED	Output state: 1 LED (yellow)
Supply voltage limits	10...36 V DC
Switching frequency	<= 5000 Hz
Maximum voltage drop	<2 V (closed)
Current consumption	<= 10 mA no-load
Maximum delay first up	10 ms
Maximum delay response	0.1 ms
Maximum delay recovery	0.1 ms
Marking	CE
Threaded length	25 mm
Height	12 mm
Length	35 mm
Net weight	0.18 kg

## Environment

Product certifications	CSA UL
Ambient air temperature for operation	-25...70 °C
Ambient air temperature for storage	-40...85 °C
Vibration resistance	25 gn amplitude = +/- 2 mm (f = 10...55 Hz) conforming to IEC 60068-2-6
Shock resistance	50 gn for 11 ms conforming to IEC 60068-2-27

## Offer Sustainability

Sustainable offer status	Green Premium product
REACH Regulation	<a href="#">REACH Declaration</a>
EU RoHS Directive	Pro-active compliance (Product out of EU RoHS legal scope) <a href="#">EU RoHS Declaration</a>
Mercury free	Yes
RoHS exemption information	<a href="#">Yes</a>
Environmental Disclosure	<a href="#">Product Environmental Profile</a>
Circularity Profile	<a href="#">End of Life Information</a>

## Contractual warranty

Warranty	18 months
----------	-----------

Dimensions

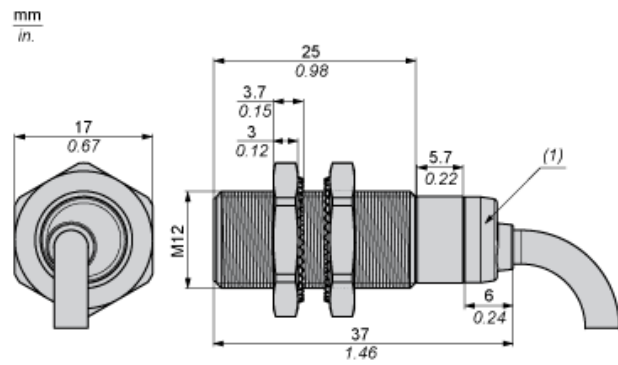

(1) LED

---

Minimum Mounting Distances

---

Side by side

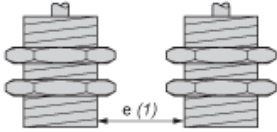

$e (1) \geq 16 \text{ mm}/0.63 \text{ in.}$

Face to face

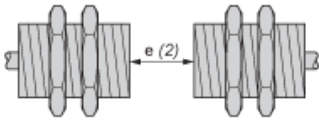

$e (2) \geq 48 \text{ mm}/1.89 \text{ in.}$

Facing a metal object

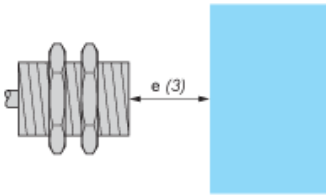

$e (3) \geq 12 \text{ mm}/0.47 \text{ in.}$

Mounted in a metal support

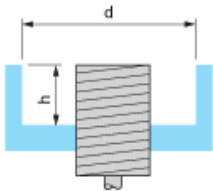

$d \geq 36 \text{ mm}/1.42 \text{ in.}$

$h \geq 8 \text{ mm}/0.31 \text{ in.}$

---

Mounting

---

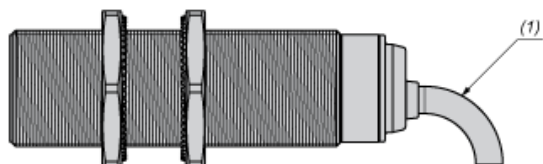

(1) Bending cable: 4 x external cable diameter

Wiring Schemes

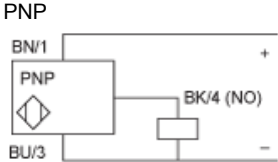

- BU : Blue
- BN : Brown
- BK : Black

---

Performance Curves

---

Standard Steel Target : 12x12x1 mm

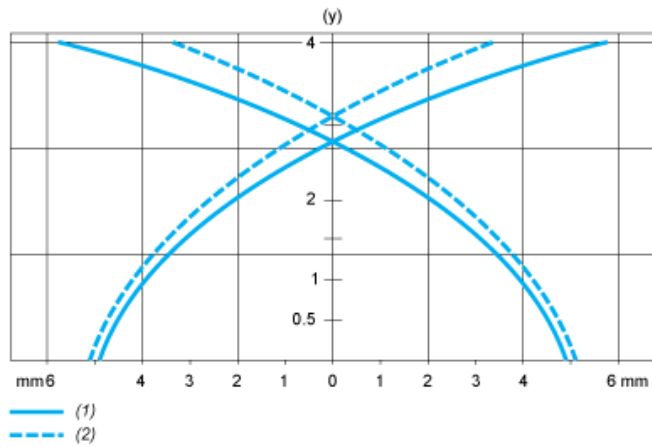

- (1) Pick-up points
- (2) Drop-out points (object approaching from the side)
- (y) Sensing distance in mm