



Main

Range of product	OsiSense XS
Series name	General purpose
Sensor type	Inductive proximity sensor
Device application	-
Sensor name	XS1
Sensor design	Cylindrical M5
Size	29 mm
Body type	Fixed
Detector flush mounting acceptance	Flush mountable
Material	Stainless steel
Type of output signal	Discrete
Wiring technique	3-wire
[Sn] nominal sensing distance	0.8 mm
Discrete output function	1 NO
Output circuit type	DC
Discrete output type	PNP
Electrical connection	Cable
Cable length	10 m
[Us] rated supply voltage	5...24 V DC
Switching capacity in mA	<= 100 mA with overload and short-circuit protection
IP degree of protection	IP67 conforming to IEC 60529

Complementary

Thread type	M5 x 0.5
Detection face	Frontal
Front material	PPS
Enclosure material	Stainless steel 303

Operating zone	0...0.6 mm
Cable composition	3 x 0.11 mm ²
Wire insulation material	PvR
Status LED	Output state: 1 LED (yellow)
Supply voltage limits	5...30 V DC
Switching frequency	<= 5000 Hz
Maximum voltage drop	<2 V (closed)
Current consumption	<= 10 mA no-load
Maximum delay first up	5 ms
Maximum delay response	1 ms
Maximum delay recovery	1 ms
Marking	CE
Threaded length	29 mm
Height	5 mm
Length	29 mm

Environment

Product certifications	UL CSA
Ambient air temperature for operation	-25...70 °C
Ambient air temperature for storage	-40...85 °C
Vibration resistance	25 gn amplitude = +/- 2 mm (f = 10...55 Hz) conforming to IEC 60068-2-6
Shock resistance	50 gn for 11 ms conforming to IEC 60068-2-27

Offer Sustainability

Sustainable offer status	Green Premium product
REACH Regulation	REACH Declaration
EU RoHS Directive	Pro-active compliance (Product out of EU RoHS legal scope) EU RoHS Declaration
Mercury free	Yes
RoHS exemption information	Yes
Environmental Disclosure	Product Environmental Profile
Circularity Profile	End of Life Information

Contractual warranty

Warranty	18 months
----------	-----------

Dimensions

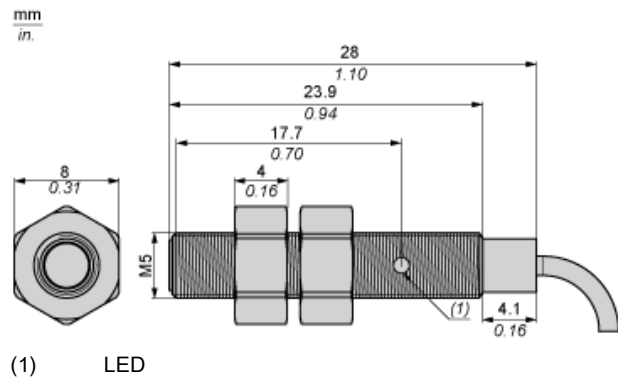

Minimum Mounting Distances in mm

Side by side

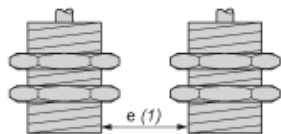

$e(1) \geq 2 \text{ mm}/0.79 \text{ in.}$

Face to face

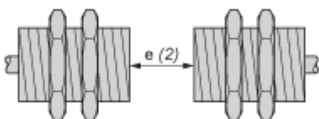

$e(2) \geq 12 \text{ mm}/0.47 \text{ in.}$

Facing a metal object

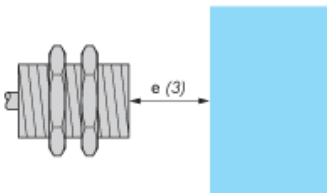

$e(3) \geq 3 \text{ mm}/0.12 \text{ in.}$

Mounted in a metal support

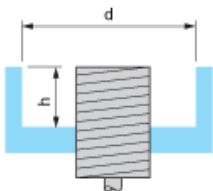

$d \geq 5 \text{ mm}/0.17 \text{ in.}$

$h \geq 0 \text{ mm}/0 \text{ in.}$

Tightening torque : 2.2 N.m. (values obtained with washers mounted)

Mounting

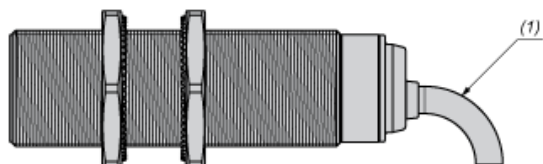

(1) Bending cable: 4 x external cable diameter

Wiring Schemes

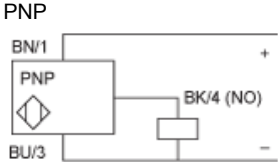

- BU : Blue
- BN : Brown
- BK : Black

Performance Curves

Standard Steel Target (mm) : 5x5x1

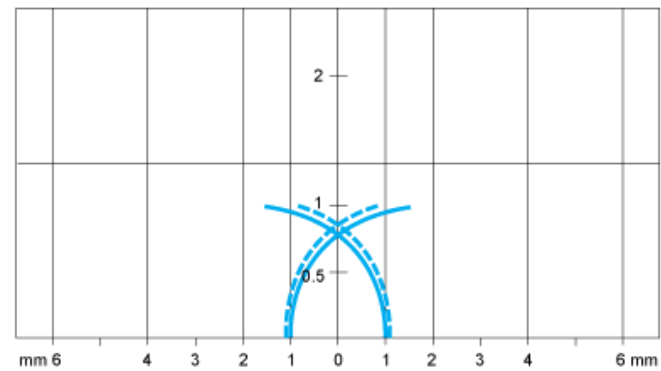

- Pick-up points
- - - Drop-out points (object approaching from the side)
- (y) Sensing distance in mm