



Main

Range of product	OsiSense XS
Series name	General purpose
Sensor type	Inductive proximity sensor
Device application	-
Sensor name	XS1
Sensor design	Cylindrical Ø 4 mm plain
Size	41 mm
Body type	Fixed
Detector flush mounting acceptance	Flush mountable
Material	Metal
Type of output signal	Discrete
Wiring technique	3-wire
[Sn] nominal sensing distance	1 mm
Discrete output function	1 NO
Output circuit type	DC
Discrete output type	NPN
Electrical connection	3 pins M8 male connector
[Us] rated supply voltage	5...24 V DC
Switching capacity in mA	<= 100 mA with overload and short-circuit protection
IP degree of protection	IP67 conforming to IEC 60529

Complementary

Detection face	Frontal
Front material	PPS
Enclosure material	Nickel plated brass
Operating zone	0...0.8 mm
Status LED	1 LED yellow for output state

Supply voltage limits	5...30 V DC
Switching frequency	<= 5000 Hz
Voltage drop	<= 2 V at closed state
Current consumption	<= 10 mA at no-load
Delay first up	<= 5 ms
Delay response	<= 1 ms
Delay recovery	<= 1 ms
Marking	CE
Threaded length	0 mm
Height	10 mm
Length	42 mm
Product weight	0.01 kg

Environment

Product certifications	CSA UL
Ambient air temperature for operation	-25...70 °C
Ambient air temperature for storage	-40...85 °C
Vibration resistance	25 gn amplitude = +/- 2 mm (f = 10...55 Hz) conforming to IEC 60068-2-6
Shock resistance	50 gn for 11 ms conforming to IEC 60068-2-27

Offer Sustainability

Sustainable offer status	Green Premium product
RoHS (date code: YYWW)	Compliant - since 0935 - Schneider Electric declaration of conformity Schneider Electric declaration of conformity
REACH	Reference not containing SVHC above the threshold Reference not containing SVHC above the threshold
Product environmental profile	Available End of Life Information
Product end of life instructions	Available

Contractual warranty

Warranty period	18 months
-----------------	-----------

Dimensions

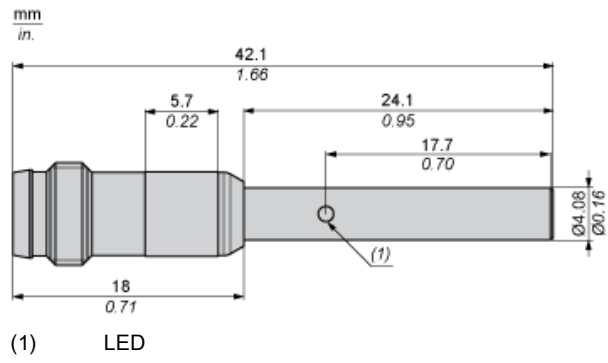

Minimum Mounting Distances in mm

Side by side

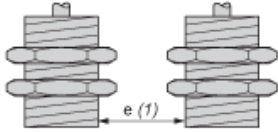

$e(1) \geq 2 \text{ mm}/0.79 \text{ in.}$

Face to face

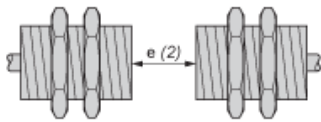

$e(2) \geq 12 \text{ mm}/0.47 \text{ in.}$

Facing a metal object

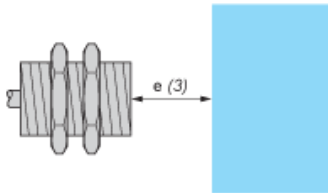

$e(3) \geq 3 \text{ mm}/0.12 \text{ in.}$

Mounted in a metal support

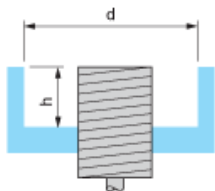

$d \geq 4 \text{ mm}/0.16 \text{ in.}$

$h \geq 0 \text{ mm}/0 \text{ in.}$

Tightening torque : 1.6 N.m. (values obtained with washers mounted)

Wiring Schemes

M8 Connector

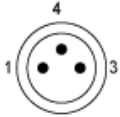

NPN

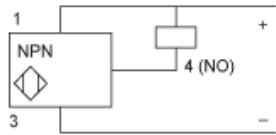

Performance Curves

Standard Steel Target (mm) : 5x5x1

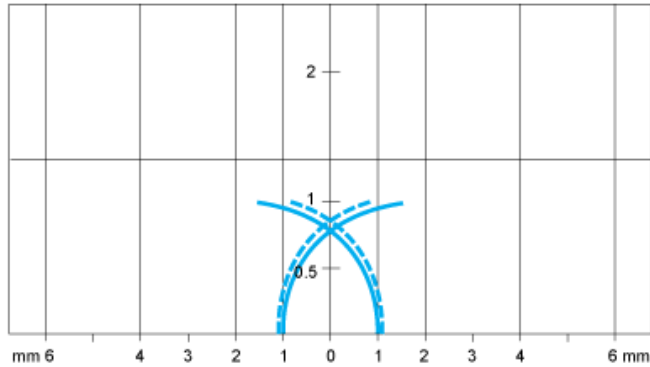

- Pick-up points
- - - Drop-out points (object approaching from the side)
- (y) Sensing distance in mm