



Main

Range of product	Lexium integrated drive
Product or component type	Motion integrated drive
Device short name	ILA
Motor type	Ac synchronous servo motor
Number of motor poles	6
Network number of phases	Single phase
[Us] rated supply voltage	24 V 48 V
Network type	DC
Communication interface	Integrated EtherCAT
Length	207.8 mm
Winding type	Medium speed of rotation and medium torque
Electrical connection	Printed circuit board connector
Holding brake	Without
Gear box type	Without
Nominal speed	1600 rpm at 24 V 3400 rpm at 48 V
Nominal torque	0.78 N.m

Complementary

Transmission rate	100 Mbits
Mounting support	Flange
Motor flange size	57 mm
Number of motor stacks	2
Centring collar diameter	50 mm
Centring collar depth	1.6 mm
Number of mounting holes	4
Mounting holes diameter	5.2 mm

Circle diameter of the mounting holes	66.6 mm
Feedback type	Multi turn encoder
Shaft end	Untapped
Second shaft	Without second shaft end
Shaft diameter	9 mm
Shaft length	20 mm
Supply voltage limits	18...55.2 V
Current consumption	7000 mA (maximum continuous) 8500 mA (peak)
Associated fuse rating	16 A
Commissioning interface	RS485 Modbus TCP (9.6, 19.2 and 38.4 kbauds)
Input/Output type	4 signals (each be used as input or output)
Voltage state 0 guaranteed	-3...4.5 V
Voltage state 1 guaranteed	15...30 V
Discrete input current	10 mA at 24 V for safety input 2 mA at 24 V for 24 V signal interface
Discrete output voltage	23...25 V
Maximum switching current	100 mA per output 200 mA total
Protection type	Overload of output voltage Safe torque off Short circuit of the output voltage
Peak stall torque	1.62 N.m
Continuous stall torque	0.78 N.m
Speed feedback resolution	16384 points/turn x 4096 turns
Accuracy error	+/- 0.05 °
Rotor inertia	0.173 kg.cm ²
Maximum radial force Fr	107 N
Maximum axial force Fa	104 N (force pressure) 104 N (tensile force)
Service life in hours	20000 h of bearing :
Marking	CE
Type of cooling	Natural convection
Product weight	1.7 kg

Environment

Standards	EN 50347 EN 61800-3:2001, second environment EN 61800-3 : 2001-02 EN/IEC 50178 EN/IEC 61800-3 IEC 60072-1 IEC 61800-3, Ed 2
Product certifications	CUL TÜV UL
Ambient air temperature for operation	0...40 °C without derating > 40...55 °C with power derating of 2 % per °C
Permissible ambient air temperature around the device	105 °C (power amplifier) 110 °C (motor)
Ambient air temperature for storage	-25...70 °C
Operating altitude	<= 1000 m without derating
Relative humidity	15...85 % without condensation
Vibration resistance	20 m/s ² (f = 10...500 Hz) for 10 cycles conforming to EN/IEC 60068-2-6
Shock resistance	150 m/s ² for 1000 shocks conforming to EN/IEC 60068-2-29
IP degree of protection	IP41 shaft bushing conforming to EN/IEC 60034-5 IP54 total except shaft bushing conforming to EN/IEC 60034-5

Offer Sustainability

Sustainable offer status	Green Premium product
RoHS (date code: YYWW)	Compliant - since 0944 - Schneider Electric declaration of conformity Schneider Electric declaration of conformity
REACH	Reference not containing SVHC above the threshold Reference not containing SVHC above the threshold
Product environmental profile	Available End of Life Information
Product end of life instructions	Available

Contractual warranty

Warranty period	18 months
-----------------	-----------

Integrated Drive without Holding Brake

Dimensions

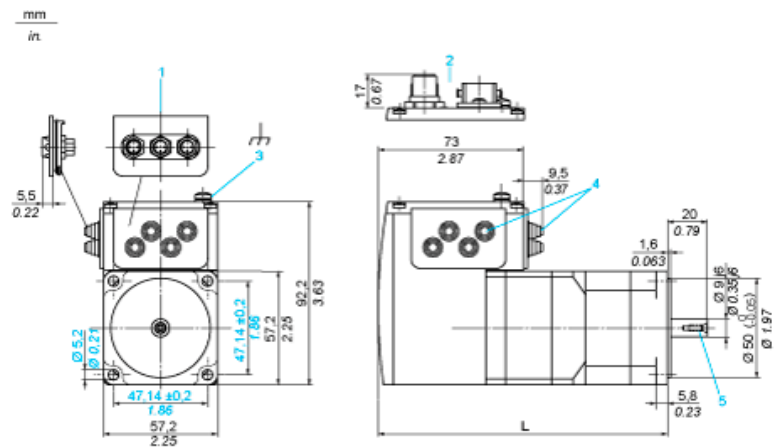

- 1 Accessories: I/O signal insert with industrial connectors
 - 2 Option: industrial connectors
 - 3 Earth (ground) terminal
 - 4 Accessories: cable entries $\varnothing = 3 \dots 9 \text{ mm} / 0.12 \dots 0.35 \text{ in.}$
 - 5 Centring hole DIN 332 - DS M3
- L : 197.3 mm / 7.77 in.

Connection Example with 4 I/O Signals

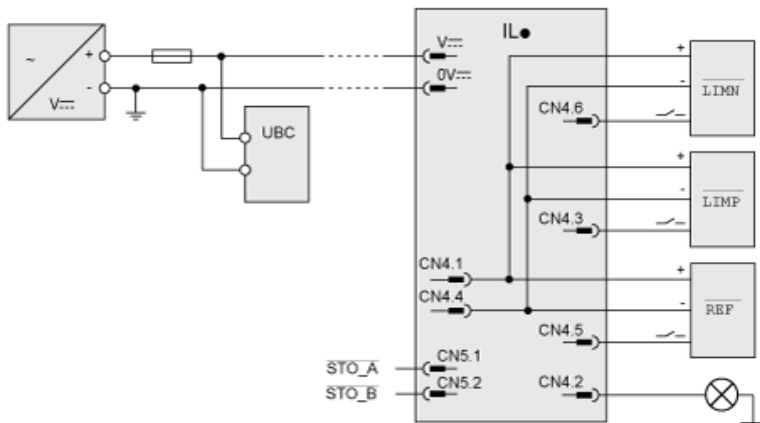

Torque Characteristics

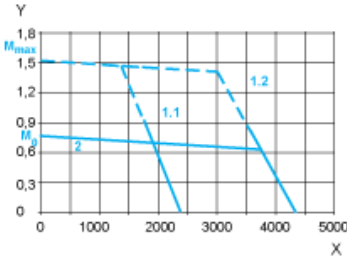

- X Speed of rotation in rpm
- Y Torque in Nm
- 1.1 Max. torque at 24 V
- 1.2 Max. torque at 48 V
- 2 Continuous torque