



Main

Range	TeSys
Product name	TeSys GV4
Device short name	GV4P
Circuit breaker functionalities	Circuit breaker
Device application	Motor
Protection type	Phase unbalance Phase loss Ground fault protection Short time short-circuit protection Short-circuit Overload
Utilisation category	Category A
Suitability for isolation	Yes conforming to IEC 60947-1
Poles description	3P
[Ue] rated operational voltage	690 V AC 50/60 Hz conforming to IEC 60947-2
[In] rated current	115 A
Trip unit technology	Thermal-magnetic Electronic
Thermal protection adjustment range	65...115 A
Motor tripping class	10 20
Breaking capacity	Icu 50 kA at 380...415 V AC 50/60 Hz conforming to IEC 60947-2 Icu 15 kA at 525 V AC 50/60 Hz conforming to IEC 60947-2 65 kA at 208Y/120 V AC 50/60 Hz conforming to UL 60947 65 kA at 240 V AC 50/60 Hz conforming to UL 60947 35 kA at 480Y/277 V AC 50/60 Hz conforming to UL 60947 Icu 8 kA at 660...690 V AC 50/60 Hz conforming to IEC 60947-2 18 kA at 600Y/347 V AC 50/60 Hz conforming to UL 60947 Icu 100 kA at 220...240 V AC 50/60 Hz conforming to IEC 60947-2 Icu 25 kA at 500 V AC 50/60 Hz conforming to IEC 60947-2 Icu 50 kA at 440 V AC 50/60 Hz conforming to IEC 60947-2
[Ics] rated service breaking capacity	100 kA at 220...240 V AC 50/60 Hz conforming to IEC 60947-2 50 kA at 380...415 V AC 50/60 Hz conforming to IEC 60947-2

Disclaimer: This documentation is not intended as a substitute for and is not to be used for determining suitability or reliability of these products for specific user applications

50 kA at 440 V AC 50/60 Hz conforming to IEC 60947-2
 25 kA at 500 V AC 50/60 Hz conforming to IEC 60947-2
 15 kA at 525 V AC 50/60 Hz conforming to IEC 60947-2
 2 kA at 660...690 V AC 50/60 Hz conforming to IEC 60947-2

[Uimp] rated impulse withstand voltage	8 kV conforming to IEC 60947-2
[Ui] rated insulation voltage	800 V conforming to IEC 60947-2

Complementary

Mechanical durability	40000 cycles
Electrical durability	10000 cyclesFor AC-3 at 440 V In/2 5000 cyclesFor AC-3 at 440 V In
Motor power kW	110 kW at 660...690 V AC 50/60 Hz 37 kW at 400...415 V AC 50/60 Hz 45 kW at 400...415 V AC 50/60 Hz 45 kW at 500 V AC 50/60 Hz 55 kW at 400...415 V AC 50/60 Hz 55 kW at 500 V AC 50/60 Hz 75 kW at 500 V AC 50/60 Hz 75 kW at 660...690 V AC 50/60 Hz 90 kW at 660...690 V AC 50/60 Hz
Control type	Rotary handle
Toggle padlocking (with accessories)	Padlock in OFF or ON position
Number of slots	1 slot(s)For alarm switchFor fault signalling contact plug-in 1 slot(s)For voltage releaseFor electrical remote tripping plug-in 1 slot(s)For auxiliary switchFor open/close contact plug-in
Local signalling	Presence of auxiliary contacts: flag (green)
Standards	EN/IEC 60947-4-1 EN/IEC 60947-2 UL 60947-4-1 CSA C22.2 No 60947-4-1
Quality labels	CE
Mounting mode	By screws By clips
Mounting support	Plate 35 mm symmetrical DIN rail 75 mm symmetrical DIN rail
Connections - terminals	Top 1 EverLink BTR screw connectors wire size 1.5...70 mm ² solid Top 1 EverLink BTR screw connectors wire size 1.5...50 mm ² flexible Bottom 1 EverLink BTR screw connectors wire size 2.5...95 mm ² solid Bottom 1 EverLink BTR screw connectors wire size 2.5...70 mm ² flexible
Connection pitch	27 mm
Wire stripping length	20 mm
Tightening torque	9 N.mFor 16...95 mm ² 5 N.mFor 1.5...10 mm ²
Width	81 mm
Height	155 mm
Depth	165 mm
Product weight	1.6 kg
Colour	Grey (RAL 7016)

Environment

Product certifications	IEC
Ambient air temperature for storage	-50...85 °C
Ambient air temperature for operation	-25...70 °C
Operating altitude	2000...5000 m with derating 0...2000 m without derating
IP degree of protection	IP40 front face conforming to IEC 60529
IK degree of protection	IK07 conforming to IEC 62262
Pollution degree	3 conforming to IEC 60947-1
Tropicalisation	2 conforming to IEC 68-2

Mechanical robustness	Vibrations: +/- 1 mm 2...13.2 Hz conforming to IEC 60068-2-6 Vibrations: 0.7 gn 13.2...100 Hz conforming to IEC 60068-2-6 Shocks: 15 gn 11 ms conforming to IEC 60068-2-27
-----------------------	--

Offer Sustainability

Sustainable offer status	Green Premium product
RoHS (date code: YYWW)	Compliant - since 1736 - Schneider Electric declaration of conformity Schneider Electric declaration of conformity
REACH	Reference not containing SVHC above the threshold Reference not containing SVHC above the threshold
Product environmental profile	Available Product Environmental Profile
Product end of life instructions	Available End of Life Information

Contractual warranty

Warranty period	18 months 18 months
-----------------	---------------------

Thermal-Magnetic Tripping Curves for GV4P, GV4PE, GV4PEM

Average Operating Times at 20 °C Related to Multiples of the Setting Current

Hot state

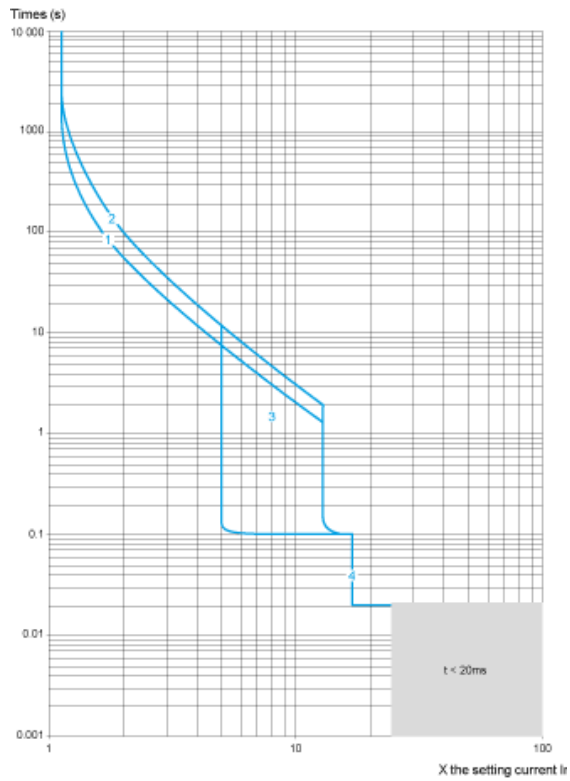

- 1 Class 10
- 2 Class 20
- 3 $I_{sd} = 5...13x I_r$
- 4 $I_i = 17 I_r$

Cold state



- 1 Class 10
- 2 Class 20
- 3 $I_{sd} = 5 \dots 13 \times I_r$
- 4 $I_i = 17 I_n$

Current Limitation on Short-Circuit for GV4P, GV4PE, GV4PEM (3-Phase 400/415 V)

Dynamic Stress

$I_{\text{peak}} = f(\text{prospective } I_{sc})$ at $1.05 U_e = 435 \text{ V}$

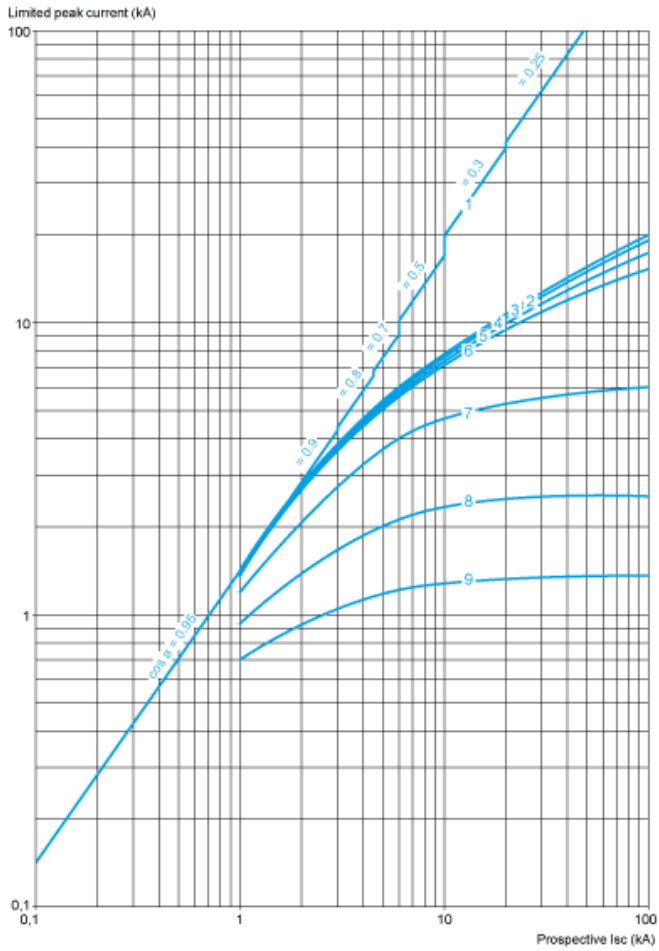

- 1 Maximum peak current
- 2 GV4P115
- 3 GV4P80
- 4 GV4P50
- 5 GV4P25
- 6 GV4P12
- 7 GV4P07
- 8 GV4P03
- 9 GV4P02

Thermal Limit on Short-Circuit for GV4P, GV4PE, GV4PEM

Thermal Limit in kA^2s in the Magnetic Operating Zone

Sum of $I^2dt = f$ (prospective Isc) at $1.05 U_e = 435 V$

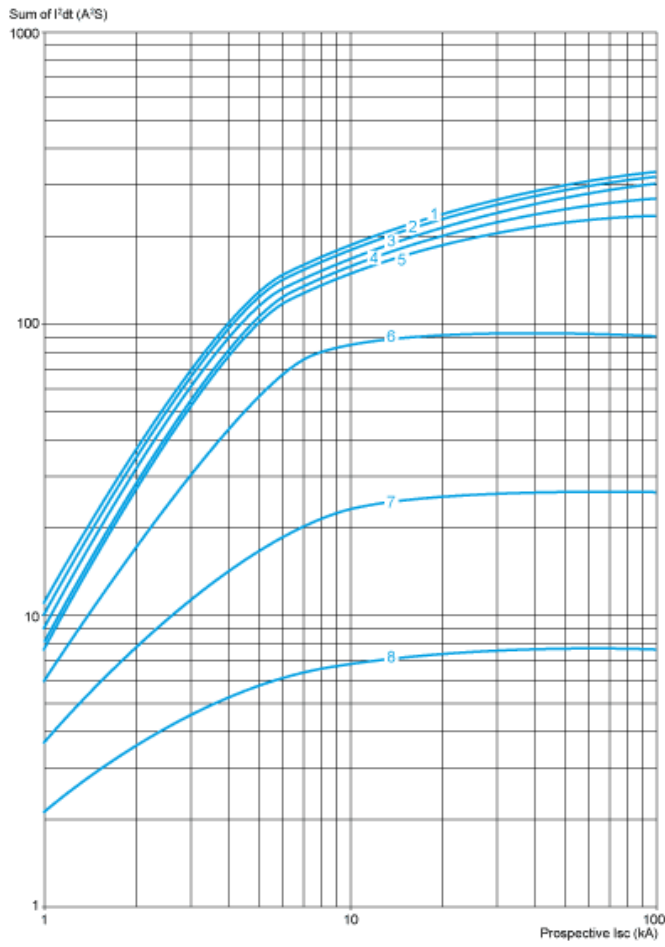

- 1 GV4P115
- 2 GV4P80
- 3 GV4P50
- 4 GV4P25
- 5 GV4P12
- 6 GV4P07
- 7 GV4P03
- 8 GV4P02

GV4 with Toggle: GV4LE, GV4PE, GV4PEM

With EverLink® Connector

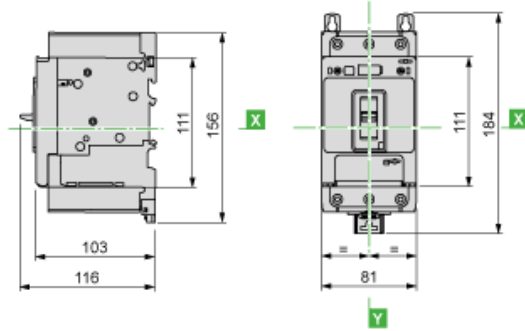

With Crimp Lug Connector

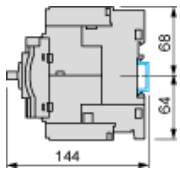

GV4 with Rotary Handle: GV4L, GV4P, or GV4LE, GV4PE, GV4PEM with GV4ADN01, GV4ADN02 Direct Mounting Rotary Handle

Dimensions

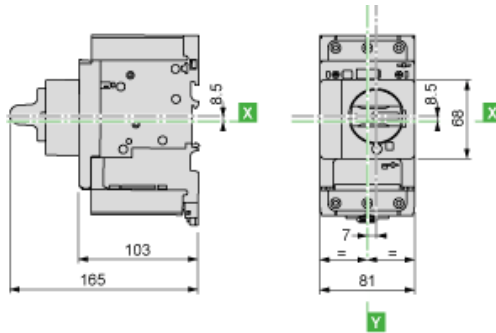

GV4L, GV4P, GV4LE, GV4PE, GV4PEM

Panel Mounting with M4 Screws

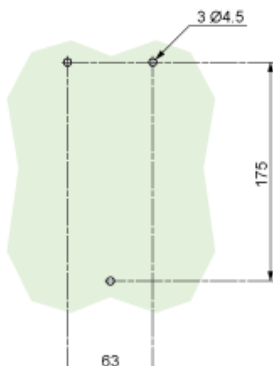

Door Cut-Out for Rotary Handle



Minimum Safety Clearance

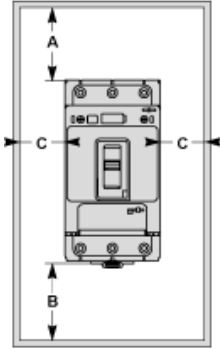

Toggle-type, rotary handle-type: identical clearance values.

Safety Clearance (mm)						
	Painted Sheet Metal			Bare Sheet Metal		
	A	B	C	A	B	C
No accessory	30	0	0	40	0	5
Interphase barriers	0	0	0	0	0	5
Long terminal shield	0	0	0	0	0	5

Magnetic Motor Circuit Breakers

GV4P, GV4PE, GV4PEM

