



Main

Range of product	Altivar Process ATV600
Product or component type	Variable speed drive
Product specific application	Process and utilities
Device short name	ATV680
Product destination	Synchronous motors Asynchronous motors
Assembly style	In floor-standing enclosure low harmonic version
IP degree of protection	IP23 conforming to IEC 61800-5-1
Supply frequency	50/60 Hz (+/- 5 %)
Network number of phases	3 phases
Motor power kW	500 kW (normal duty) 400 kW (heavy duty)
Line current	646 A at 480 V (normal duty) 519 A at 480 V (heavy duty)

Complementary

Provided equipment	Enclosure Spacial SF Graphical operating panel in the enclosure door Frequency inverter Main switch Terminal block for main supply Terminal block for motor Semiconductor fuses Clean power filter with EMC filter Active infeed converter module
Cable entry	Bottom
Colour of enclosure	Light grey RAL 7035
Type of cooling	Forced convection
[Us] rated supply voltage	480 V (+/- 10 %)
Overvoltage category	III
Asynchronous motor control profile	Optimized torque mode Variable torque standard Constant torque standard
Synchronous motor control profile	Permanent magnet motor
Output voltage	<= power supply voltage

Disclaimer: This documentation is not intended as a substitute for and is not to be used for determining suitability or reliability of these products for specific user applications

Permissible temporary current boost	1.1 x I _n for 60 s (normal duty) 1.5 x I _n for 60 s (heavy duty)
Nominal switching frequency	2.5 kHz
Switching frequency	2...8 kHz adjustable with derating factor
Speed drive output frequency	0.1...500 Hz
Speed accuracy	V/f mode: slip frequency VC without feedback: 0.3 x slip frequency
Continuous output current	830 A at 2.5 kHz (normal duty) 660 A at 2.5 kHz (heavy duty)
Maximum transient current	913 A during 60 s per 10 min (normal duty) 990 A during 60 s per 10 min (heavy duty)
Apparent power	537 kVA at 480 V (normal duty) 432 kVA at 480 V (heavy duty)
THDI	<= 5 % full load conforming to IEC 61000-3-12
Short-circuit protection	400 A, 3 fuse type aR for internal 1000 A fuse type gG for upstream (normal duty) 800 A fuse type gG for upstream (heavy duty)
Energy efficiency ratio	0.965
Power dissipation in W	18210 W, total (normal duty) 13960 W, total (heavy duty) 2060 W, control part (normal duty) 1560 W, control part (heavy duty)
Volume of cooling air	420 m ³ /h (control) 3480 m ³ /h (power)
Prospective line I _{sc}	50 kA for 100 ms
Electrical connection	Control : removable screw terminals, 0.5...1.5 mm ² Main supply : M12 bar Motor : M12 bar
Motor recommended cable cross section	4 x (3 x 95 mm ²) heavy duty 4 x (3 x 150 mm ²) normal duty 5 x (3 x 120 mm ²) normal duty 3 x (3 x 150 mm ²) heavy duty
Width	1600 mm
Height	2150 mm
Depth	664 mm
Product weight	1150 kg
Number of preset speeds	16 preset speeds
Communication port protocol	Modbus TCP Ethernet/IP Modbus serial
Option card	Slot A/slot B : digital and analog I/O extension module Slot A/slot B : output relay extension module Slot A : communication module, Profibus DP V1 Slot A : communication module, Profinet Slot A : communication module, DeviceNet Slot A : communication module, Modbus TCP/EtherNet/IP Slot A : communication module, CANopen daisy chain RJ45 Slot A : communication module, CANopen SUB-D 9 Slot A : communication module, CANopen screw terminals
Safety function	STO (safe torque off), level SIL 3
Motor slip compensation	Automatic whatever the load Can be suppressed Adjustable Not available in permanent magnet motor law
Acceleration and deceleration ramps	Linear adjustable separately from 0.01 to 9000 s S, U or customized
Braking to standstill	By DC injection
Protection type	Motor : thermal protection Motor : safe torque off Motor : motor phase break Drive : thermal protection Drive : safe torque off Drive : overheating Drive : short-circuit protection

Drive : motor phase break
 Drive : line supply overvoltage
 Drive : line supply undervoltage
 Drive : line supply phase loss
 Drive : overspeed
 Drive : break on the control circuit
 Drive : overcurrent (between output phases and earth)
 Drive : overload (output)
 Drive : overvoltage (DC bus)
 Drive : short-circuit protection with semi-conductor fuse (main supply)
 Drive : fan monitoring

Frequency resolution	Display unit : 0.1 Hz Analog input : 0.012/50 Hz
Connector type	For Modbus serial RJ45 (on the control block) For Ethernet IP/Modbus TCP RJ45 (on the control block)
Physical interface	2-wire RS 485 for Modbus serial
Transmission frame	RTU for Modbus serial
Transmission rate	10/100 Mbit/s for Ethernet IP/Modbus TCP 4.8, 9.6, 19.2, 38.4 kbit/s for Modbus serial
Exchange mode	Half duplex, full duplex, autonegotiation for Ethernet IP/Modbus TCP
Data format	8 bits, configurable odd, even or no parity for Modbus serial
Type of polarization	No impedance for Modbus serial
Number of addresses	1...247 for Modbus serial
Method of access	Slave[Sapce]: Modbus TCP
Supply	External supply for digital inputs : 24 V DC (19...30 V) current \leq 1.25 mA (overload and short-circuit protection) Internal supply for reference potentiometer (1 to 10 kOhm) : 10.5 V DC \pm 5 % current \leq 10 mA (overload and short-circuit protection) Internal supply for digital inputs and STO : 24 V DC (21...27 V) current \leq 200 mA (overload and short-circuit protection)
Local signalling	LCD display unit operation function, status and configuration on front door
Analogue input number	3
Analogue input type	Software-configurable voltage AI1, AI2, AI3 : 0...10 V DC impedance 30 kOhm, resolution 12 bits Software-configurable current AI1, AI2, AI3 : 0...20 mA impedance 250 Ohm, resolution 12 bits
Discrete input number	8
Discrete input type	Programmable DI1...DI6 : 24 V DC (\leq 30 V) impedance 3.5 kOhm Programmable as pulse input DI5, DI6 0...30 kHz : 24 V DC (\leq 30 V) Safe torque off STOA, STOB : 24 V DC (\leq 30 V) impedance $>$ 2200 kOhm
Input compatibility	Discrete input DI1...DI6 : level 1 PLC conforming to EN/IEC 61131-2 Discrete input DI5, DI6 : level 1 PLC conforming to IEC 65A-68 Discrete input STOA, STOB : level 1 PLC conforming to EN/IEC 61131-2
Discrete input logic	DI1...DI6, positive logic (source) : $<$ 5 V (state 0) $>$ 11 V (state 1) DI1...DI6, negative logic (sink) : $>$ 16 V (state 0) $<$ 10 V (state 1) DI5, DI6, positive logic (source) : $<$ 0.6 V (state 0) $>$ 2.5 V (state 1) STOA, STOB, positive logic (source) : $<$ 5 V (state 0) $>$ 11 V (state 1)
Analogue output number	2
Analogue output type	Software-configurable voltage : (AQ1, AQ2) 0...10 V DC - 470 Ohm, resolution 10 bits Software-configurable current : (AQ1, AQ2) 0...20 mA, resolution 10 bits
Sampling duration	Discrete input DI1...DI4 : 2 ms (\pm 0.5 ms) Discrete input DI5, DI6 : 5 ms (\pm 1 ms) Analog input AI1, AI2, AI3 : 5 ms (\pm 1 ms) Analog output AQ1, AQ2 : 10 ms (\pm 1 ms)
Accuracy	Analog input AI1, AI2, AI3 : \pm 0.6 % for a temperature variation 60 °C Analog output AQ1, AQ2 : \pm 1 % for a temperature variation 60 °C
Linearity error	Analog input AI1, AI2, AI3 : \pm 0.15 % of maximum value Analog output AQ1, AQ2 : \pm 0.2 %
Relay output number	3
Relay output type	Configurable relay logic R1 : fault relay NO/NC electrical durability 100000 cycles Configurable relay logic R2 : sequence relay NO electrical durability 100000 cycles Configurable relay logic R3 : sequence relay NO electrical durability 100000 cycles
Refresh time	Relay output R1, R2, R3 : 5 ms (\pm 0.5 ms)
Minimum switching current	Relay output R1, R2, R3 : 5 mA at 24 V DC
Maximum switching current	Relay output R1, R2, R3 on resistive load (cos phi = 1) : 3 A at 250 V AC Relay output R1, R2, R3 on resistive load (cos phi = 1) : 3 A at 30 V DC

Relay output R1, R2, R3 on inductive load (cos phi = 0.4 and L/R = 7 ms : 2 A at 250 V AC
 Relay output R1, R2, R3 on inductive load (cos phi = 0.4 and L/R = 7 ms : 2 A at 30 V DC

Isolation	Between power and control terminals
Insulation resistance	> 1 mOhm at 500 V DC for 1 minute to earth
Operating position	Vertical +/- 10 degree
Relative humidity	5...95 % without condensation conforming to IEC 60068-2-3

Environment

Noise level	75 dB conforming to 86/188/EEC - physical agents (noise) directive
EMC filter	Integrated conforming to EN/IEC 61800-3, category C4, unshielded cable with <= 250 m motor cable maxi
Pollution degree	2 EN/IEC 61800-5-1
Electromagnetic compatibility	1.2/50 µs - 8/20 µs surge immunity test level 3 conforming to IEC 61000-4-5 Electrical fast transient/burst immunity test level 4 conforming to IEC 61000-4-4 Electrostatic discharge immunity test level 3 conforming to IEC 61000-4-2 Radiated radio-frequency electromagnetic field immunity test level 3 conforming to IEC 61000-4-3 Conducted radio-frequency immunity test level 3 conforming to IEC 61000-4-6
Vibration resistance	3M3 conforming to IEC 60721-3-3 1.5 mm peak to peak (f = 3...10 Hz) conforming to IEC 60068-2-6 0.6 gn (f = 10...200 Hz) conforming to IEC 60068-2-6
Shock resistance	3M2 conforming to IEC 60721-3-3 4 gn during 11 ms conforming to IEC 60068-2-27
Ambient air temperature for operation	40...50 °C with derating factor -10...0 °C without derating with option enclosure heating 0...40 °C without derating
Ambient air temperature for storage	-25...70 °C
Operating altitude	< 1000 m without derating 2000...3800 m with current derating 1 % per 100 m for TT earthing system 2000...3800 m with current derating 1 % per 100 m for TN earthing system 2000...3800 m with current derating 1 % per 100 m for IT earthing system 3800...4800 m with current derating 1 % per 100 m for TT earthing system 3800...4800 m with current derating 1 % per 100 m for TN earthing system 1000...2000 m with current derating 1 % per 100 m
Environmental characteristic	Chemical pollution resistance class 3C3 conforming to EN/IEC 60721-3-3 Dust pollution resistance class 3S3 conforming to EN/IEC 60721-3-3 Humidity resistant class 3K3 conforming to EN/IEC 60721-3-3
Standards	EN/IEC 60204-1 EN/IEC 61800-5-1 EN/IEC 61800-3 EN/IEC 61800-2
Product certifications	EAC ATEX C-Tick
Marking	CE

Dimensions

Right and Front Views

mm
in.

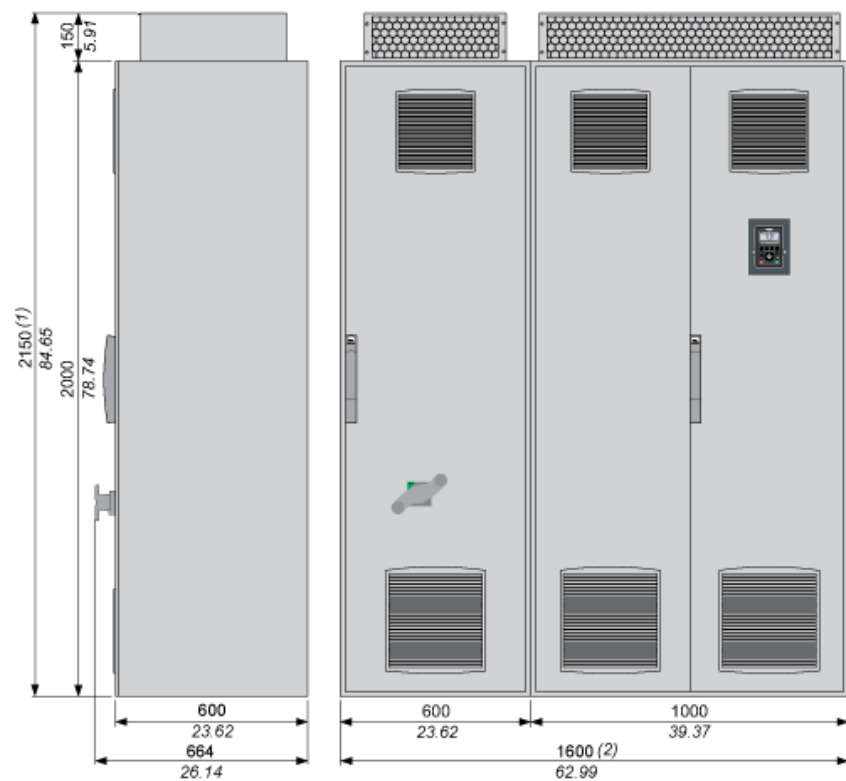

- (1) + 200 mm/7.87 in. with option enclosure plinth or increased protection degree IP54.
- (2) + 600 mm/15.74 in. with option connection enclosure cable from top/bottom.

Mounting and Clearance

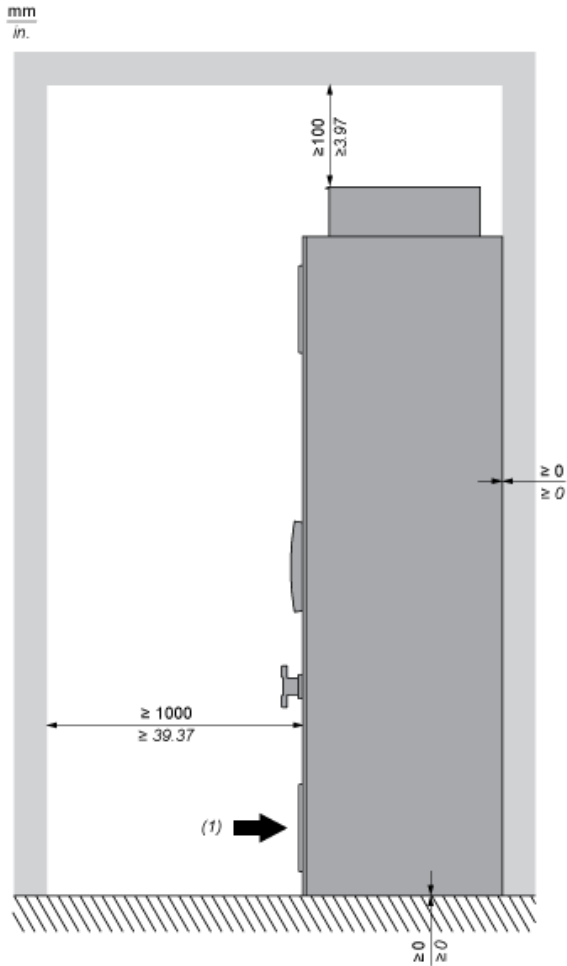

(1) Air inflow temperature: -10...+50 °C (below 0 °C with option enclosure heating, above +40 °C with derating).

Typical Wiring Diagram of the Frequency Inverter

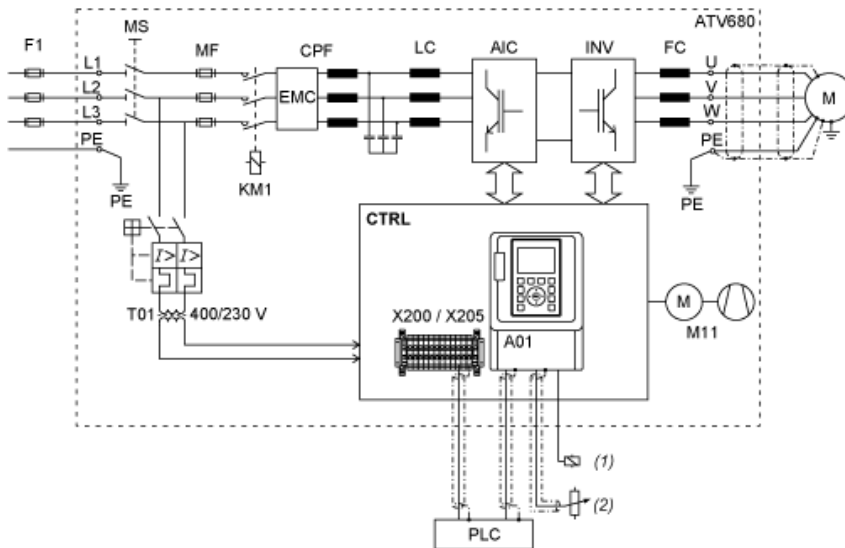

- F1 : External pre-fuse or circuit breaker
- MS : Built-in main switch
- T01 : Control transformer 400 / 230 V AC
- MF : aR fuses
- CPF : Clean Power Filter with integrated EMC filter
- LC : Line reactor Chokes
- AIC : Active Infeed Converter module
- INV : Inverter module
- FC : dv/dt filter (from 200 kW the dv/dt filter choke 150 m is built-in as standard)
- CTRL : Control panel
- A01 : Control terminals at the control block
- X200 / X205 : Control terminals at the control panel (depending on the chosen options)
- M11 : Fan in enclosure door
- KM1 : Line contactor
- (1) Relay control
- (2) Reference value

Structure of the Control Block

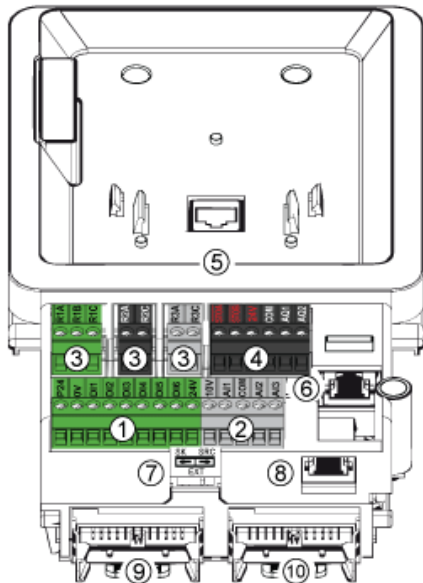

- (1) Digital inputs
- (2) Analog inputs
- (3) Relay outputs
- (4) STO (Safe Torque Off) and analog outputs
- (5) RJ45 port for door mounting kit of the graphic keypad
- (6) RJ45 port for Ethernet IP or Modbus TCP
- (7) Sink-Ext-Source selector switch (see switch configuration below)
- (8) RJ45 port for serial Modbus
- (9) Slot for I/O expansion card
- (10) Slot for fieldbus or I/O expansion card

Control Block Wiring Diagram

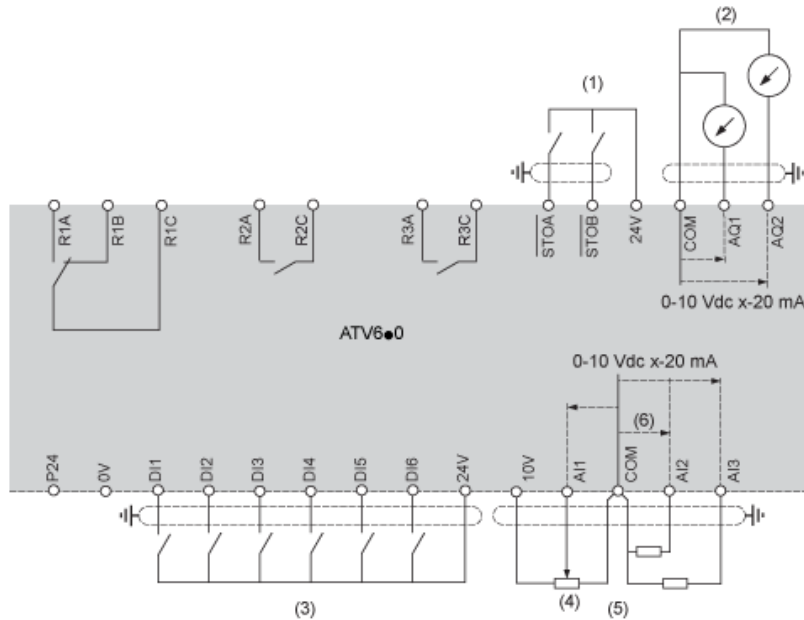

- (1) Safe Torque Off
 - (2) Analog Output
 - (3) Digital Input
 - (4) Reference potentiometer
 - (5) Analog Input
- R1A, R1B, R1C Relay
R2A, R2C Sequence relay
R3A, R3C Sequence relay

Sensor Connection

It is possible to connect either 1 or 3 sensors on terminals AI2 or AI3.

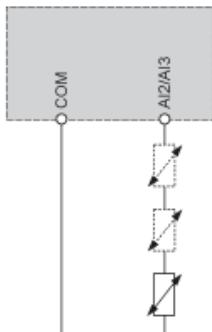

Sink / Source Switch Configuration

The switch is used to adapt the operation of the logic inputs to the technology of the programmable controller outputs.

- Set the switch to Source (factory setting) if using PLC outputs with PNP transistors.
- Set the switch to Ext if using PLC outputs with NPN transistors.

Switch Set to SRC (Source) Position Using the Output Power Supply for the Digital Inputs

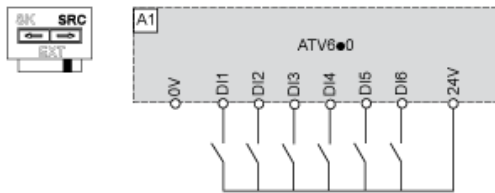

Switch Set to SRC (Source) Position and Use of an External Power Supply for the DIs

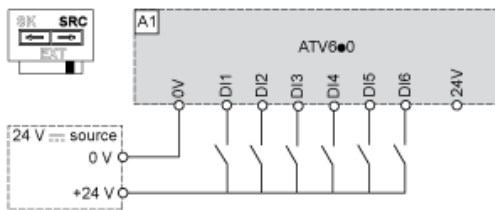

Switch Set to SK (Sink) Position Using the Output Power Supply for the Digital Inputs

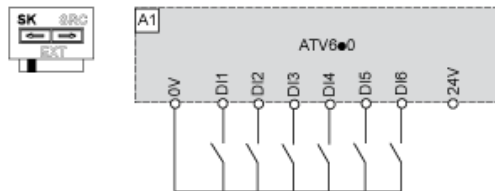

Switch Set to EXT Position Using an External Power Supply for the DIs

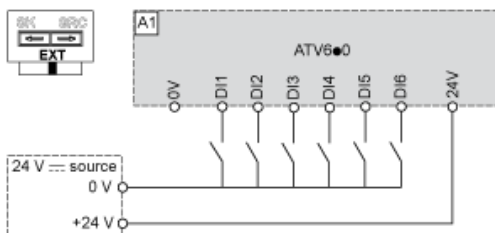

Derating Curves

Normal Duty

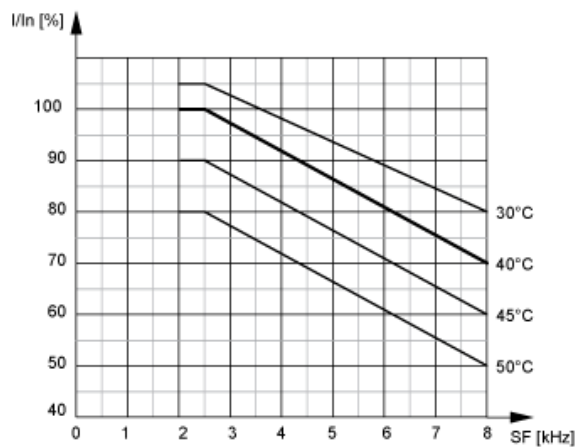

In : Nominal Drive Current
SF : Switching Frequency

Heavy Duty

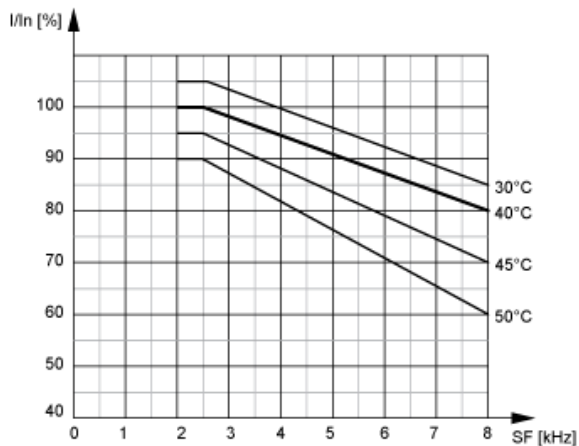

In : Nominal Drive Current
SF : Switching Frequency