



Main

Range of product	Altivar Process ATV600
Product or component type	Variable speed drive
Product specific application	Process and utilities
Device short name	ATV660
Product destination	Asynchronous motors Synchronous motors
Assembly style	In floor-standing enclosure compact version
Provided equipment	Enclosure Spacial SF Graphical operating panel in the enclosure door Frequency inverter Main switch Line choke Terminal block for main supply Terminal block for motor
Cable entry	Bottom
Colour of enclosure	Light grey RAL 7035
IP degree of protection	IP23 conforming to IEC 61800-5-1
Type of cooling	Forced convection
[Us] rated supply voltage	380...415 V (- 10...6 %)
Supply frequency	50/60 Hz (+/- 5 %)
Network number of phases	3 phases
Overvoltage category	III
Asynchronous motor control profile	Constant torque standard Variable torque standard Optimized torque mode
Synchronous motor control profile	Permanent magnet motor
Output voltage	<= power supply voltage
Permissible temporary current boost	1.1 x In for 60 s (normal duty) 1.5 x In for 60 s (heavy duty)
Nominal switching frequency	2.5 kHz
Switching frequency	2...8 kHz adjustable with derating factor

Disclaimer: This documentation is not intended as a substitute for and is not to be used for determining suitability or reliability of these products for specific user applications

Speed drive output frequency	0.1...500 Hz
Motor power kW	500 kW (normal duty) 400 kW (heavy duty)
Continuous output current	730 A at 2.5 kHz (heavy duty) 900 A at 2.5 kHz (normal duty)
Maximum transient current	990 A during 60 s per 10 min (normal duty) 1095 A during 60 s per 10 min (heavy duty)
Line current	846 A at 400 V (normal duty) 681 A at 400 V (heavy duty)
Apparent power	586 kVA at 400 V (normal duty) 472 kVA at 400 V (heavy duty)
THDI	<= 39 % at full load conforming to IEC 61000-3-12
Short-circuit protection	400 A, 3 fuse type aR for internal 1000 A fuse type gG for upstream (normal duty) 800 A fuse type gG for upstream (heavy duty)
Energy efficiency ratio	0.98
Power dissipation in W	13330 W, total (normal duty) 9800 W, total (heavy duty) 1530 W, control part (normal duty) 1020 W, control part (heavy duty)
Volume of cooling air	1740 m ³ /h (power) 280 m ³ /h (control)
Noise level	71 dB conforming to 86/188/EEC - physical agents (noise) directive
Prospective line I _{sc}	50 kA for 100 ms
Electrical connection	Control : removable screw terminals, 0.5...1.5 mm ² Main supply : M12 bar Motor : M12 bar
Motor recommended cable cross section	5 x (3 x 120 mm ²) normal duty 4 x (3 x 185 mm ²) normal duty 3 x (3 x 185 mm ²) heavy duty 4 x (3 x 120 mm ²) heavy duty
Width	800 mm
Height	2150 mm
Depth	664 mm
Product weight	650 kg
Number of preset speeds	16 preset speeds
Communication port protocol	Ethernet/IP Modbus serial Modbus TCP
Option card	Slot A/slot B : digital and analog I/O extension module Slot A/slot B : output relay extension module Slot A : communication module, Profibus DP V1 Slot A : communication module, Profinet Slot A : communication module, DeviceNet Slot A : communication module, Modbus TCP/EtherNet/IP Slot A : communication module, CANopen daisy chain RJ45 Slot A : communication module, CANopen SUB-D 9 Slot A : communication module, CANopen screw terminals
Safety function	STO (safe torque off), level SIL 3 for <= 100 ms
EMC filter	Integrated conforming to EN/IEC 61800-3, category C3, shielded cable with <= 150 m maxi Integrated conforming to EN/IEC 61800-3, category C4, unshielded cable with <= 250 m maxi

Complementary

Motor slip compensation	Adjustable Automatic whatever the load Can be suppressed Not available in permanent magnet motor law
Acceleration and deceleration ramps	Linear adjustable separately from 0.01 to 9000 s S, U or customized
Braking to standstill	By DC injection
Protection type	Motor : thermal protection Motor : safe torque off Motor : motor phase break

Drive : thermal protection
 Drive : safe torque off
 Drive : overheating
 Drive : short-circuit protection
 Drive : motor phase break
 Drive : line supply overvoltage
 Drive : line supply undervoltage
 Drive : line supply phase loss
 Drive : overspeed
 Drive : break on the control circuit
 Drive : overcurrent (between output phases and earth)
 Drive : overload (output)
 Drive : overvoltage (DC bus)
 Drive : short-circuit protection with semi-conductor fuse (main supply)
 Drive : fan monitoring

Frequency resolution	Display unit : 0.1 Hz Analog input : 0.012/50 Hz
Connector type	RJ45 (on the control block) for Modbus serial RJ45 (on the control block) for Ethernet IP/Modbus TCP
Physical interface	2-wire RS 485 for Modbus serial
Transmission frame	RTU for Modbus serial
Transmission rate	10/100 Mbit/s for Ethernet IP/Modbus TCP 4.8, 9.6, 19.2, 38.4 kbit/s for Modbus serial
Exchange mode	Half duplex, full duplex, autonegotiation for Ethernet IP/Modbus TCP
Data format	8 bits, configurable odd, even or no parity for Modbus serial
Type of polarization	No impedance for Modbus serial
Number of addresses	1...247 for Modbus serial
Method of access	Slave for Modbus TCP
Supply	Internal supply for reference potentiometer (1 to 10 kOhm) : 10.5 V DC +/- 5 % current <= 10 mA (overload and short-circuit protection) Internal supply for digital inputs and STO : 24 V DC (21...27 V) current <= 200 mA (overload and short-circuit protection) External supply for digital inputs : 24 V DC (10...30 V) current <= 1.25 mA (overload and short-circuit protection)
Local signalling	LCD display unit operation function, status and configuration on front door
Analogue input number	3
Analogue input type	Software-configurable voltage AI1, AI2, AI3 : 0...10 V DC impedance 30 kOhm , resolution 12 bits Software-configurable current AI1, AI2, AI3 : 0...20 mA impedance 250 Ohm , resolution 12 bits
Discrete input number	8
Discrete input type	Programmable DI1...DI6 : 24 V DC (limits : <= 30 V) impedance 3.5 kOhm Programmable as pulse input DI5, DI6 0...30 kHz : 24 V DC (limits : <= 30 V) Safe torque off STOA, STOB : 24 V DC (limits : <= 30 V) impedance > 2.2 kOhm
Input compatibility	Discrete input DI1...DI6 : level 1 PLC conforming to EN/IEC 61131-2 Discrete input DI5, DI6 : level 1 PLC conforming to IEC 65A-68 Discrete input STOA, STOB : level 1 PLC conforming to EN/IEC 61131-2
Discrete input logic	DI1...DI6, positive logic (source) : < 5 V (state 0) > 11 V (state 1) DI1...DI6, negative logic (sink) : > 16 V (state 0) < 10 V (state 1) DI5, DI6, positive logic (source) : < 0.6 V (state 0) > 2.5 V (state 1) STOA, STOB, positive logic (source) : < 5 V (state 0) > 11 V (state 1)
Analogue output number	2
Analogue output type	Software-configurable voltage AQ1, AQ2 : 0...10 V DC impedance 470 Ohm , resolution 10 bits Software-configurable current AQ1, AQ2 : 0...20 mA , resolution 10 bits
Sampling duration	Discrete input DI1...DI4 : 2 ms (+/- 0.5 ms) Discrete input DI5, DI6 : 5 ms (+/- 1 ms) Analog input AI1, AI2, AI3 : 5 ms (+/- 1 ms) Analog output AQ1, AQ2 : 10 ms (+/- 1 ms)
Accuracy	Analog input AI1, AI2, AI3 : +/- 0.6 % for a temperature variation 60 °C Analog output AQ1, AQ2 : +/- 1 % for a temperature variation 60 °C
Linearity error	Analog input AI1, AI2, AI3 : +/- 0.15 % of maximum value Analog output AQ1, AQ2 : +/- 0.2 %
Relay output number	3
Relay output type	Configurable relay logic R1 : fault relay NO/NC electrical durability 100000 cycles Configurable relay logic R2 : sequence relay NO electrical durability 100000 cycles Configurable relay logic R3 : sequence relay NO electrical durability 100000 cycles

Refresh time	Relay output R1, R2, R3 : 5 ms (+/- 0.5 ms)
Minimum switching current	Relay output R1, R2, R3 : 5 mA at 24 V DC
Maximum switching current	Relay output R1, R2, R3 on resistive load (cos phi = 1 : 3 A at 250 V AC Relay output R1, R2, R3 on resistive load (cos phi = 1 : 3 A at 30 V DC Relay output R1, R2, R3 on inductive load (cos phi = 0.4 L/R = 7 ms) : 2 A at 250 V AC Relay output R1, R2, R3 on inductive load (cos phi = 0.4 L/R = 7 ms) : 2 A at 30 V DC
Isolation	Between power and control terminals

Environment

Insulation resistance	> 1 mOhm at 500 V DC for 1 minute to earth
Operating position	Vertical +/- 10 degree
Electromagnetic compatibility	1.2/50 µs - 8/20 µs surge immunity test level 3 conforming to IEC 61000-4-5 Electrical fast transient/burst immunity test level 4 conforming to IEC 61000-4-4 Electrostatic discharge immunity test level 3 conforming to IEC 61000-4-2 Radiated radio-frequency electromagnetic field immunity test level 3 conforming to IEC 61000-4-3 Conducted radio-frequency immunity test level 3 conforming to IEC 61000-4-6
Pollution degree	2 conforming to EN/IEC 61800-5-1
Vibration resistance	1.5 mm peak to peak (f= 3...10 Hz) conforming to IEC 60068-2-6 0.6 gn (f= 10...200 Hz) conforming to IEC 60068-2-6 3M3 conforming to IEC 60721-3-3
Shock resistance	4 gn (duration = 11 ms) conforming to IEC 60068-2-27 3M2 conforming to IEC 60721-3-3
Relative humidity	5...95 % without condensation conforming to IEC 60068-2-3
Ambient air temperature for operation	40...50 °C with derating factor -10...0 °C without derating with option enclosure heating 0...40 °C without derating
Ambient air temperature for storage	-25...70 °C
Operating altitude	< 1000 m without derating 2000...3800 m with current derating 1 % per 100 m for TT earthing system 2000...3800 m with current derating 1 % per 100 m for TN earthing system 2000...3800 m with current derating 1 % per 100 m for IT earthing system 3800...4800 m with current derating 1 % per 100 m for TT earthing system 3800...4800 m with current derating 1 % per 100 m for TN earthing system 1000...2000 m with current derating 1 % per 100 m
Environmental characteristic	Chemical pollution resistance class 3C3 conforming to EN/IEC 60721-3-3 Dust pollution resistance class 3S3 conforming to EN/IEC 60721-3-3 Humidity resistant class 3K3 conforming to EN/IEC 60721-3-3
Standards	EN/IEC 60204-1 EN/IEC 61800-3 EN/IEC 61800-5-1 EN/IEC 61800-2
Product certifications	EAC ATEX C-Tick
Marking	CE

Offer Sustainability

Sustainable offer status	Green Premium product
RoHS (date code: YYWW)	Compliant - since 1516 - Schneider Electric declaration of conformity Schneider Electric declaration of conformity
REACH	Reference not containing SVHC above the threshold Reference not containing SVHC above the threshold
Product environmental profile	Available Product Environmental Profile
Product end of life instructions	Available End of Life Information

Dimensions

Right and Front Views

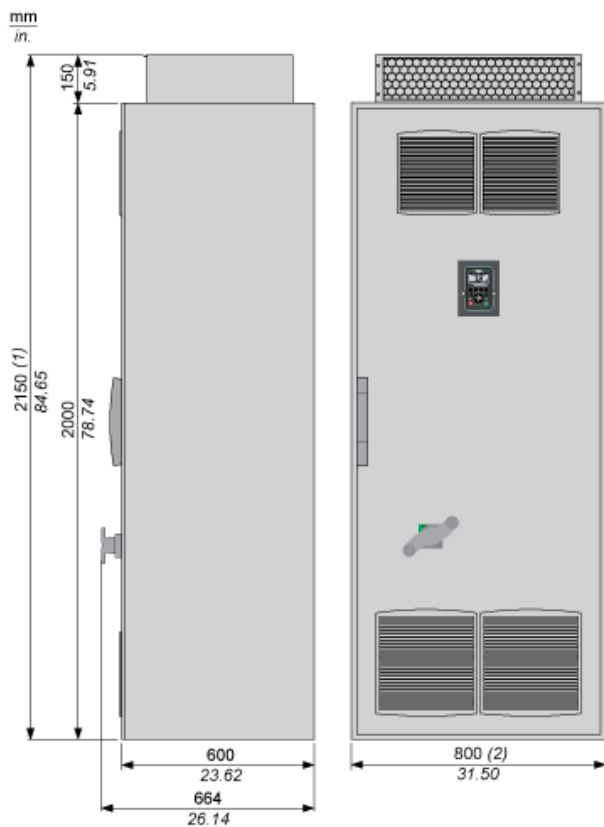

- (1) + 200 mm / 7.87 in. with option enclosure plinth or increased protection degree IP54
- (2) + 600 mm / 23.62 in. with option connection enclosure cable from top/bottom

Mounting and Clearance

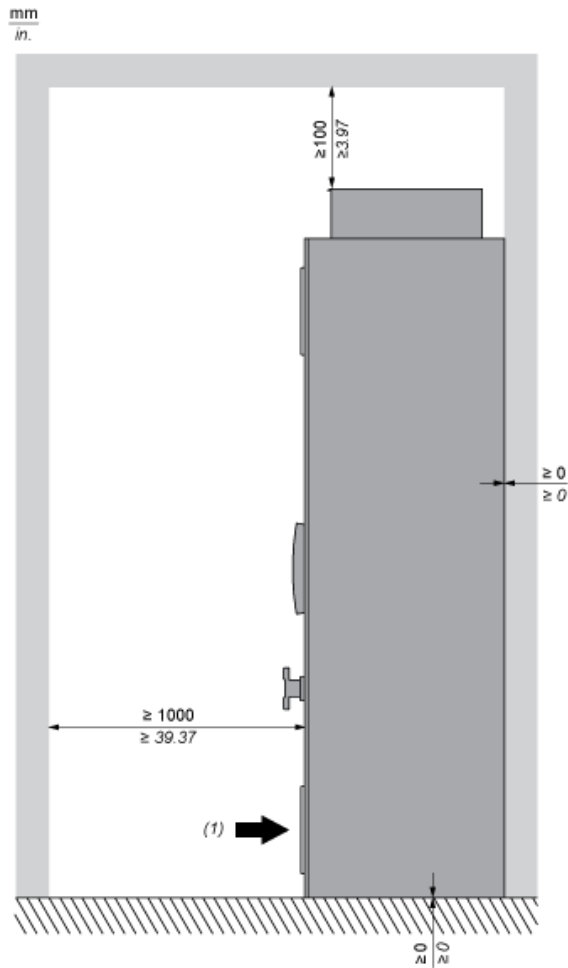

(1) Air inflow temperature: -10...+50 °C (below 0 °C with option enclosure heating, above +40 °C with derating).

Typical Wiring Diagram of the Frequency Inverter

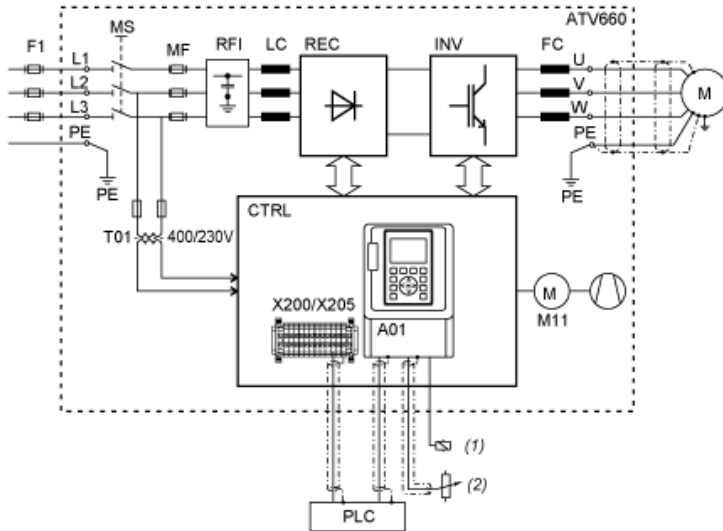

- F1 External pre-fuse or circuit breaker
- MS Built-in main switch
- T01 Control transformer 400 / 230 V AC
- MF aR fuses
- RFI Built-in RFI filter
- LC Line reactor choke
- REC Rectifier module
- INV Inverter module
- FC dv/dt filter (from 355 kW the dv/dt filter choke 150 m is built-in as standard)
- CTRL Control panel
- A01 Control terminals at the control block
- X200 / X205 Control terminals at the control panel (depending on the chosen options)
- M11 Fan in enclosure door
- (1) Relay control
- (2) Reference value

Structure of the Control Block

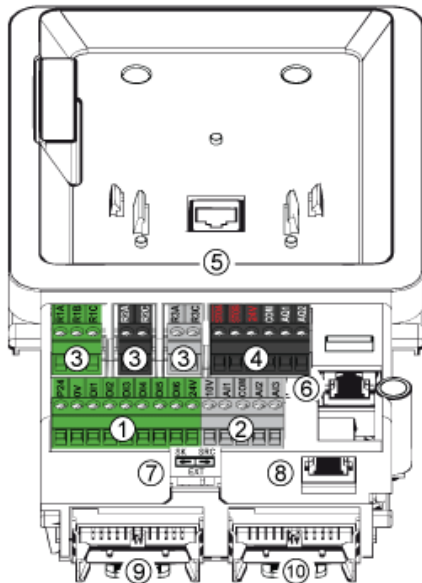

- (1) Digital inputs
- (2) Analog inputs
- (3) Relay outputs
- (4) STO (Safe Torque Off) and analog outputs
- (5) RJ45 port for door mounting kit of the graphic keypad
- (6) RJ45 port for Ethernet IP or Modbus TCP
- (7) Sink-Ext-Source selector switch (see switch configuration below)
- (8) RJ45 port for serial Modbus
- (9) Slot for I/O expansion card
- (10) Slot for fieldbus or I/O expansion card

Control Block Wiring Diagram

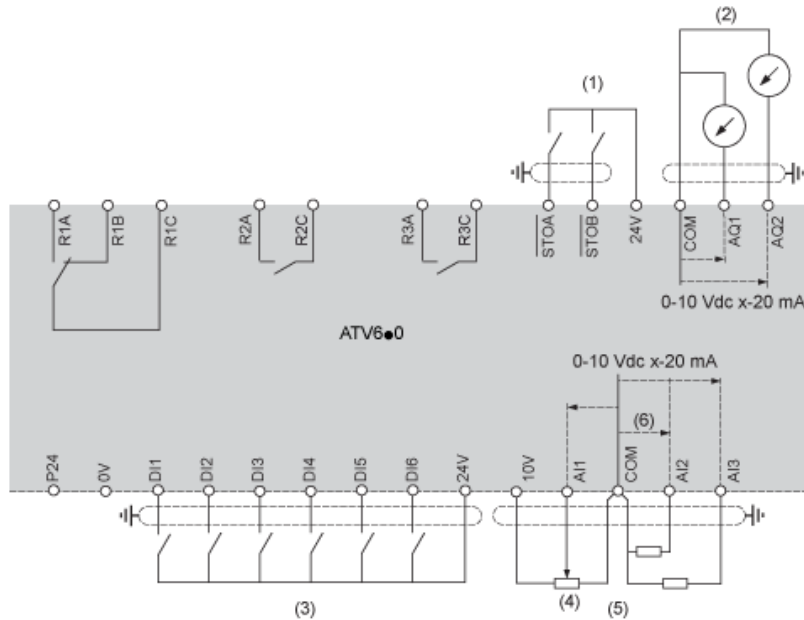

- (1) Safe Torque Off
 - (2) Analog Output
 - (3) Digital Input
 - (4) Reference potentiometer
 - (5) Analog Input
 - (6) COM
- R1A, R1B, R1C Relay
R2A, R2C Sequence relay
R3A, R3C Sequence relay

Sensor Connection

It is possible to connect either 1 or 3 sensors on terminals AI2 or AI3.

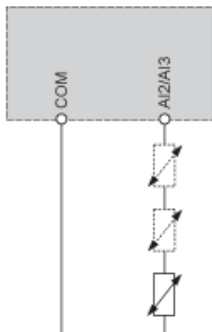

Sink / Source Switch Configuration

The switch is used to adapt the operation of the logic inputs to the technology of the programmable controller outputs.

- Set the switch to Source (factory setting) if using PLC outputs with PNP transistors.
- Set the switch to Ext if using PLC outputs with NPN transistors.

Switch Set to SRC (Source) Position Using the Output Power Supply for the Digital Inputs

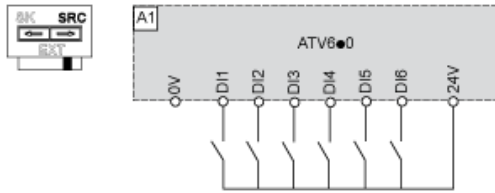

Switch Set to SRC (Source) Position and Use of an External Power Supply for the DIs

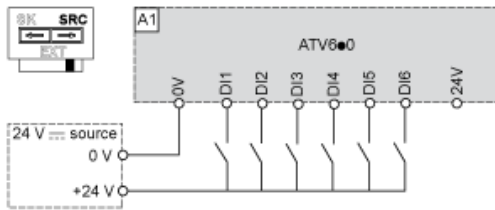

Switch Set to SK (Sink) Position Using the Output Power Supply for the Digital Inputs

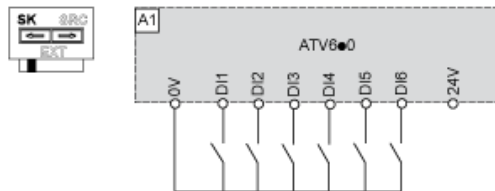

Switch Set to EXT Position Using an External Power Supply for the DIs

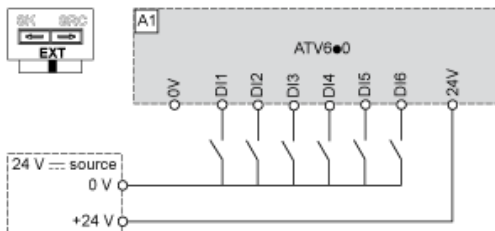

Derating Curves

Normal Duty

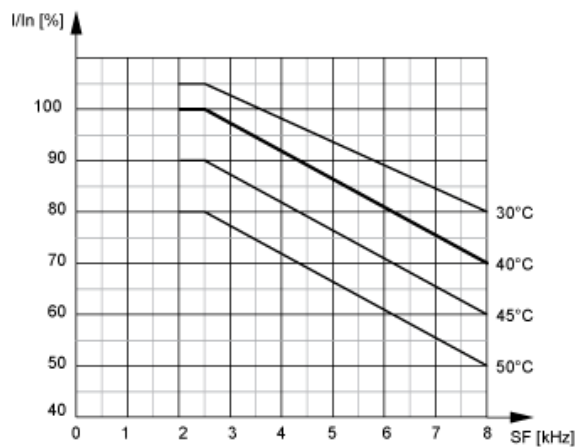

In : Nominal Drive Current
SF : Switching Frequency

Heavy Duty

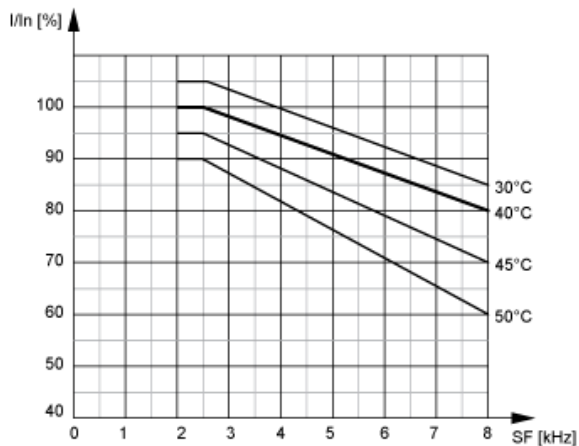

In : Nominal Drive Current
SF : Switching Frequency